

BEDFORD[®]

SPRAY EQUIPMENT PARTS

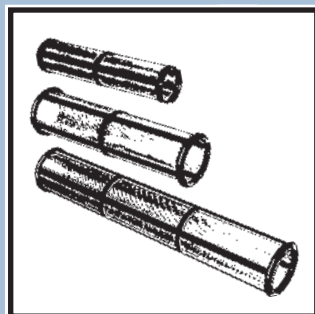
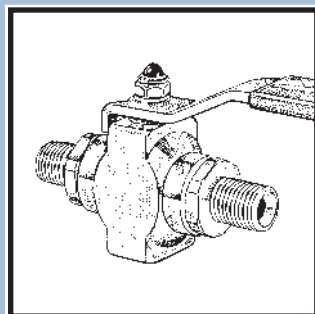
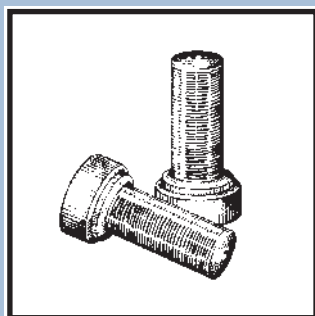
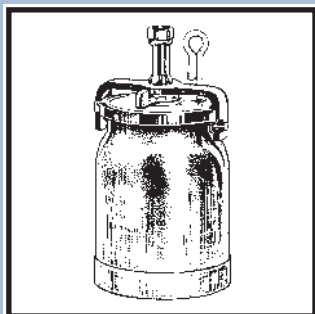
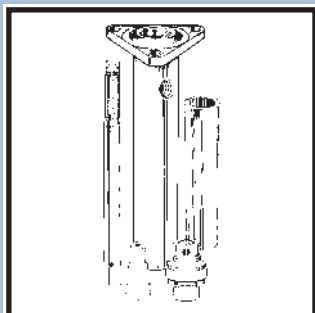
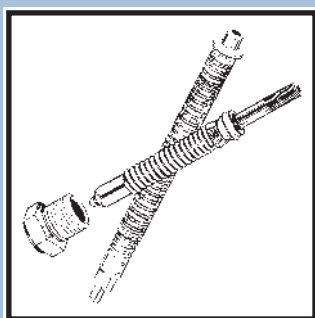
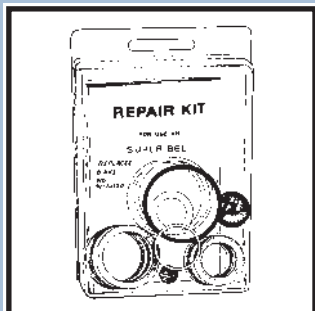

Spray Paint Equipment End-User Catalog December 2011

Parts and Components for:

- AIRLESSCO
- AMSPRAY
- ASM
- BINKS
- DEVILBISS
- GLIDDEN
- GRACO
- H.E.R.O.
- KREMLIN
- LARIUS
- SHARPE
- SPEEFLO
- TITAN
- WAGNER
- SHERWIN-WILLIAMS

Your local Bedford dealer is:

To order, contact your local
Paint Spray Equipment Dealer and ask for
Genuine Bedford Replacement Parts.

BEDFORD® Replacement Parts For . . . AIRLESSCO Equipment

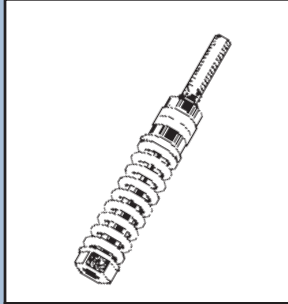

PART NO. 58-2001
REPLACES 120-011

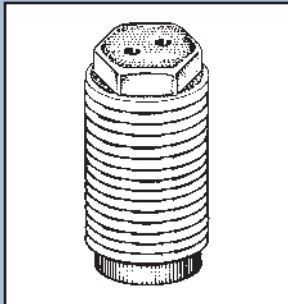

PART NO. 58-2022
REPLACES 120-035

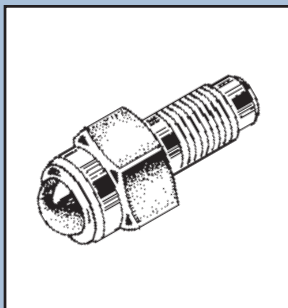

PART NO. 58-2024
REPLACES 120-037

REPLACES AIRLESSCO PART NO.	BEDFORD PART NO.	DESCRIPTION	AIRLESSCO LIST PRICE (\$)
101-047	17-2238	Valve Label "OPEN-CLOSED"	—
106-009	15-1990	Teflon O-Ring	1.39
106-011	15-1998	Teflon O-Ring	4.34
106-012	15-1824	Teflon O-Ring	8.12
106-013	0-1825	O-Ring	5.93
106-014	0-1827	O-Ring	5.36
106-015	15-1832	Teflon O-Ring	2.59
106-016	0-1833	O-Ring	2.27
106-017	15-1834	Teflon O-Ring	4.77
106-018	15-1826	Teflon O-Ring	5.34
106-020	15-2052	Teflon O-Ring	4.73
106-021	15-2406	Teflon O-Ring	2.09
115-017	9-1818	Ball, 7/32", Carbide	9.87
115-022	9-1819	Ball, 5/16", Carbide	33.18
115-050	9-1820	Ball, 11/32", Carbide	32.16
120-007	58-2239	Carbide Ball Seat	17.10
120-008	8-2018	Tip Washer	—
120-011	58-2001	Valve Spring Unit - 007 Gun	48.50
120-012	12-2025	Guide	8.57
120-013	23-2026	Spring	3.68
120-014	44-2027	Shaft	22.90
120-021	19-2007	Locknut	2.09
120-032	18-2028	Male Adapter	7.22
120-033	2-2029	Seal, Teflon	4.58
120-034	18-2030	Female Adapter	6.68
120-035	58-2022	Diffuser/Valve Seat Assembly - 007 Gun	47.44
120-037	58-2024	Ball Holder Assembly - 007 Gun	23.56
141-008	14-1817	Inlet Strainer, 3/4" NPT Thread	10.26
186-032	6-1821	Piston Seal	3.79
187-020	9-1822	Ball	8.93
187-022	17-1894	Ball Stop	5.40
187-027T	—	Replaced by 106-012 (15-1824)	—
187-027V	—	Replaced by 106-013 (0-1825)	—
187-028T	—	Replaced by 106-018 (15-1826)	—
187-028V	—	Replaced by 106-014 (0-1827)	—
187-029	49-2407	V-Packing	3.52
187-029L	—	Replaced by 187-059 (1-1828)	—
187-029T	2-1829	Teflon V-Packing	—
187-030	49-2408	V-Packing	3.64
187-030L	—	Replaced by 187-060 (1-1830)	—
187-030T	2-1831	Teflon V-Packing	—
187-033T	—	Replaced by 106-015 (15-1832)	—
187-033V	—	Replaced by 106-016 (0-1833)	—
187-034T	—	Replaced by 106-017 (15-1834)	—
187-037	18-2409	Male Adapter	17.55
187-040	20-1815	Kit - 3600, 4100, 5100, 5300, 6100 Pumps	76.38
187-042	20-1947	Kit - 3600, 4100, 5100, 5300, 6100 Pumps	—
187-045	—	Replaced by 115-022 (9-1819)	—
187-058	18-2308	Female Gland	10.71
187-059	1-1828	Leather V-Packing	9.92
187-060	1-1830	Leather V-Packing	7.13
189-023P	18-1835	Female Adapter	23.56
189-028L	1-1836	Leather V-Packing	13.77
189-028T	2-1837	Teflon V-Packing	5.64
189-034T	15-1838	Teflon O-Ring	11.56
189-035T	15-1839	Teflon O-Ring	6.02
189-036T	15-1840	Teflon O-Ring	4.68
189-063	9-1841	Ball	22.41
189-376	20-1816	Kit - 8100, 9100 Pumps	178.45
331-014	18-1986	Male Adapter	2.15

AIRLESSCO LIST PRICES ARE BASED ON SINGLE UNIT PRICE IN AIRLESSCO U.S. PRICE LIST DATED 11/11

BEDFORD® Replacement Parts For . . . AIRLESSCO Equipment

To order, contact your local
Paint Spray Equipment Dealer and ask for
Genuine Bedford Replacement Parts.

REPLACES AIRLESSCO PART NO.	BEDFORD PART NO.	DESCRIPTION	AIRLESSCO LIST PRICE (\$)
331-015D	18-2277	Female Adapter, Double-Sided	—
331-016	49-1988	V-Packing	2.15
331-016L	1-1989	Leather V-Packing	—
331-020T	—	Replaced by 106-009 (15-1990)	—
331-020V	0-1991	O-Ring	—
331-021	18-1992	Female Adapter	2.15
331-022	18-1993	Male Adapter	2.15
331-023	49-1994	V-Packing	2.15
331-023L	1-1995	Leather V-Packing	—
331-026	58-2925	Outlet Seat - Power Pup, Little Pro	23.70
331-027	9-1996	Ball	2.15
331-030	9-1997	Ball	2.70
331-032T	—	Replaced by 106-011 (15-1998)	—
331-036T	—	Replaced by 106-020 (15-2052)	—
331-093	57-2930	Piston Rod Assembly - Little Pro, Power Pup	204.00
331-100	15-1985	Teflon O-Ring	2.09
331-105	0-2240	O-Ring	2.15
331-210	20-1999	Kit - Little Pro, Power Pup, 2400, 2500, 2600	65.25
331-211	20-2241	Kit - Prime & Pressure Relief Valve	36.40
331-314	12-2926	Retainer	14.70
331-708	57-2928	Piston Rod - Little Pro, Power Pup	156.50
KIT-1-007	55-2019	Tip Washers (12-pack)	—
KIT-2-007	20-2031	Ball Holder & Seal Kit - 007 Gun	61.66
KIT-3-007	20-2032	Kit - 007 Gun (Complete), Marathon Valve	71.94

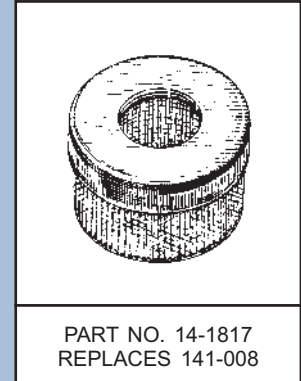

AIRLESSCO LIST PRICES ARE BASED ON SINGLE UNIT PRICE IN AIRLESSCO U.S. PRICE LIST DATED 1/1/11

BEDFORD® Replacement Parts For . . . ASM Equipment

To order, contact your local
Paint Spray Equipment Dealer and ask for
Genuine Bedford Replacement Parts.

Note: 6-Digit ASM P/Ns can be found in the Graco section beginning on page 16

REPLACES ASM PART NO.	BEDFORD PART NO.	DESCRIPTION	ASM LIST PRICE (\$)
3027-F	—	Order as: 4427-F (20-2234)	—
3027-G	—	Order as: 4427-G (20-2393)	—
4402-F	58-2232	Diffuser - 300/400 Gun (11/16 "F" Thread)	38.30
4402-G	58-2385	Diffuser - 300/400 Gun (7/8 "G" Thread)	38.30
4404	47-2227	Ball Mount & Valve Plunger Assembly	45.20
4405	47-2229	Ball Mount Assembly	22.10
4412	6-2223	External Seal	2.40
4425	55-2226	Valve Stem Locknuts (3-pack)	6.10
4426-F	20-2233	Kit - 300/400 Gun ("F" Diffuser & Ball Mount)	54.50
4426-G	20-2392	Kit - 300/400 Gun ("G" Diffuser & Ball Mount)	56.75
4427-F	20-2234	Kit - 300/400 Gun ("F" Diffuser, Ball/Plunger)	75.25
4427-G	20-2393	Kit - 300/400 Gun ("G" Diffuser, Ball/Plunger)	75.25
4428	47-2235	Valve Plunger Assembly - 300/400 Gun	29.60
4433-2	55-2721	Gun Filters, 50 Mesh, White, Medium (2-Pk)	8.30
4434-2	55-2722	Gun Filters, 100 Mesh, Yellow, Fine (2-Pk)	8.30
4435-2	55-2723	Gun Filters, 200 Mesh, Red, Extra-Fine (2-Pk)	8.30
4436-2	55-2724	Gun Filters, 30 Mesh, Green, Coarse (2-Pk)	8.30

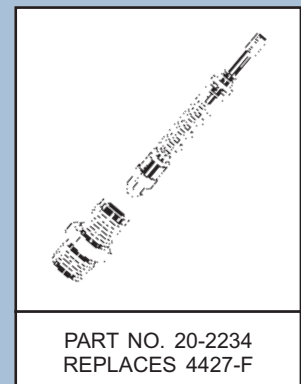

ASM LIST PRICES ARE BASED ON SINGLE UNIT PRICE IN ASM U.S. PRICE LIST DATED 1/1/11

To order, contact your local
Paint Spray Equipment Dealer and ask for
Genuine Bedford Replacement Parts.

BEDFORD® Replacement Parts For . . . BINKS Equipment

Quick Reference for . . . BINKS Spray Guns

SPRAY GUN	REPAIR KIT		PACKING KIT		PACKING KIT (10 PACK)	
	REPLACES BINKS PART NO.	BEDFORD PART NO.	REPLACES BINKS PART NO.	BEDFORD PART NO.	REPLACES BINKS PART NO.	BEDFORD PART NO.
MODEL 7	6-188	20-324	6-213	20-317	6-216	20-1065
MODEL 18	6-189	20-328	6-214	20-318	6-217	20-1066
MODEL 62	—	—	6-163	20-1019	6-169	20-321
MODEL 69	6-195	20-329	6-185	20-322	6-186	20-761
MODEL 95	54-3577	20-2154	54-4225	20-2080	—	—
MODEL 2001 & 2100	6-229	20-1175	6-231	20-1148	6-230	20-1147
MODEL 2001P	6-409	20-1501	—	—	—	—
MACH 1 / BBR	54-3605	20-1880	54-4225	20-2080	—	—
MACH 1A	54-3980	20-2340	—	—	—	—

Quick Reference for . . . BINKS Pumps

FLUID PUMP	For the Bedford Replacement Part, refer to the following Binks component part numbers:					
	PUMP REPAIR KIT	UPPER PACKING SET	LOWER PACKING SET	PISTON ROD	LOWER BALL SEAT	UPPER BALL SEAT
HUMDINGER	41-12815	41-12822	41-12823	41-12703	41-12795	41-2460
SUPER BEE	41-10320	41-10074	41-10079	41-10091	41-10275	41-10084
HORNET	41-9656	41-9614	41-9613	—	—	—
SUPER HORNET	41-9745	41-9788	41-9791	—	—	—
WASP	41-9656	41-9614	41-9613	—	—	—

NOTE: Binks part numbers that are packaged and sold as multi-packs (-K5, -K10, etc.) are listed in this catalog as the single piece component part numbers and priced as such. When ordering these parts, order by the individual piece part number in any quantity desired.



Replacement Parts for . . . BINKS

REPLACES BINKS PART NO.	BEDFORD PART NO.	DESCRIPTION	BINKS LIST PRICE (\$)
2-56	2-1842	Teflon Packing	—
6-163	20-1019	Packing Kit - #62 Gun	—
6-169	20-321	Packing Kits - #62 Gun (10-Pack)	—
6-185	20-322	Packing Kit - #69 Gun	—
6-188	20-324	Repair Kit - #7 Gun	17.25
6-189	20-328	Repair Kit - #18 Gun	—
6-195	20-329	Repair Kit - #69 Gun	—
6-213	20-317	Packing Kit - #7 Gun	—
6-214	20-318	Packing Kit - #18 Gun	—
6-216	20-1065	Packing Kits - #7 Gun (10-Pack)	—
6-217	20-1066	Packing Kits - #18 Gun (10-Pack)	—
6-229	20-1175	Repair Kit - #2001, #2100 Guns	11.75
6-230	20-1147	Packing Kits - #2001 Gun (10-Pack)	—
6-231	20-1148	Packing Kit - #2001 Gun	—
6-409	20-1501	Repair Kit - #2001P Gun	—

BINKS LIST PRICES ARE BASED ON SINGLE UNIT PRICE IN BINKS U.S. PRICE LIST DATED 1/11/11

BEDFORD® Replacement Parts For . . . BINKS Equipment

To order, contact your local
Paint Spray Equipment Dealer and ask for
Genuine Bedford Replacement Parts.

REPLACES BINKS PART NO.	BEDFORD PART NO.	DESCRIPTION	BINKS LIST PRICE (\$)
20-1544	9-179	Ball	1.32
20-2111	0-1720	O-Ring	5.10
20-2194	9-252	Ball	—
20-2198	0-335	O-Ring	1.02
20-2200	9-121	Ball	—
20-2227	0-1244	O-Ring	1.02
20-2288-1	12-1482	Plug, 1/4" NPT with Hex Socket End	3.05
20-2606-1	19-1663	Screw	—
20-2630	9-611	Ball	6.10
20-2631	9-177	Ball	5.10
20-3022	0-154	O-Ring	—
20-3023	0-685	O-Ring	—
20-3157	0-1359	O-Ring	—
20-3201	0-1716	O-Ring	—
20-3236	0-1503	O-Ring	.70
20-3248	0-1715	O-Ring	5.10
20-3250	9-333	Ball	10.95
20-3276	0-1245	O-Ring	—
20-3515	0-1712	O-Ring	1.02
20-3562	15-1017	Teflon O-Ring	5.10
20-3599	15-1848	Teflon O-Ring	5.10
20-3620	0-2330	O-Ring	1.58
20-3757	0-1141	O-Ring	5.10
20-3847	0-1719	O-Ring	5.10
20-3859	0-1323	O-Ring	1.38
20-3955	9-1179	Ball	15.75
20-4067	12-407	Swivel Adapter 1/2" NPT(m) x 3/8" NPS(f)	—
20-4232	9-136	Ball	6.35
20-4256	12-251	Swivel Adapter 3/8" NPT(f) x 3/8" NPS(f)	—
20-4276	12-411	Swivel Adapter 1/2" NPT(f) x 3/8" NPS(f)	—
20-4277	12-412	Swivel Adapter 1/2" NPT(f) x 1/2" NPS(f)	—
20-4278	12-413	Swivel Adapter 3/4" NPT(f) x 3/4" NPS(f)	—
20-4281	12-405	Swivel Adapter 3/8" NPT(m) x 3/8" NPS(f)	16.00
20-4283	12-465	Swivel Adapter 1/2" NPT(m) x 1/2" NPS(f)	9.15
20-4429	0-956	O-Ring	3.15
20-4445	0-1714	O-Ring	—
20-4455	12-408	Swivel Adapter 3/4" NPT(m) x 3/4" NPS(f)	—
20-4468	12-403	Swivel Adapter 1/4" NPT(m) x 3/8" NPS(f)	—
20-4511	0-2276	O-Ring	5.60
20-4564	—	Functionally equivalent to 81-307 (12-971)	—
20-4615	15-1718	Teflon O-Ring	1.22
20-4728	0-419	O-Ring	—
20-4731	6-666	Backup Ring	—
20-4962	9-659	Ball	26.65
20-4963	9-615	Ball	19.05
20-5052	0-1713	O-Ring	3.35
20-5205	0-1381	O-Ring	—
20-5285	0-1142	O-Ring	1.02
20-5286	0-2339	O-Ring	5.10
20-5430	9-137	Ball	—

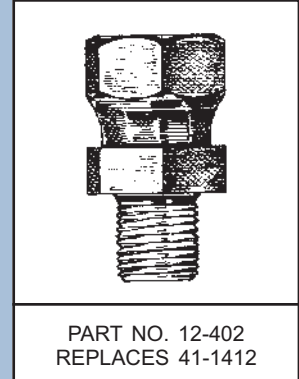

BINKS LIST PRICES ARE BASED ON SINGLE UNIT PRICE IN BINKS U.S. PRICE LIST DATED 1/1/11

To order, contact your local
Paint Spray Equipment Dealer and ask for
Genuine Bedford Replacement Parts.

BEDFORD® Replacement Parts For . . . BINKS Equipment



ART NO. 57-1000
REPLACES 41-10091

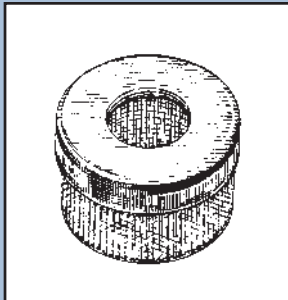

PART NO. 14-674
REPLACES 41-10094

REPLACES BINKS PART NO.	BEDFORD PART NO.	DESCRIPTION	BINKS LIST PRICE (\$)
20-5740	15-1717	Teflon O-Ring	2.49
20-6160	15-2153	Teflon O-Ring	5.10
20-6536	19-1956	Packing Removal Screw	—
41-1242	2-887	Teflon V-Packing	3.05
41-1295	10-595	Gasket	—
41-1346	1-1247	Leather V-Packing	8.15
41-1412	12-402	Swivel Adapter 1/4" NPT(m) x 1/4" NPS(f)	—
41-1434	2-199	Teflon V-Packing	5.10
41-1530	1-664	Leather V-Packing	5.10
41-1533	1-641	Leather V-Packing	5.10
41-1596	1-436	Leather V-Packing	—
41-1597	1-513	Leather V-Packing	—
41-1670	2-168	Teflon V-Packing	—
41-1671	2-169	Teflon V-Packing	—
41-1691	1-530	Leather V-Packing	6.10
41-1692	1-1262	Leather V-Packing	6.10
41-1695	2-200	Teflon V-Packing	5.10
41-1700	1-910	Leather V-Packing	6.30
41-1804	10-646	Seal	—
41-1898	1-642	Leather V-Packing	—
41-2075	2-170	Teflon V-Packing	—
41-2277	2-337	Teflon V-Packing	—
41-2421	2-338	Teflon V-Packing	—
41-2422	4-1392	Teflon Cup	—
41-2442	10-645	Gasket	—
41-2456	2-197	Teflon V-Packing	4.10
41-2457	2-198	Teflon V-Packing	5.10
41-2460	58-1891	Upper Ball Seat - Humdinger	—
41-2627	14-345	Filter Element - .006 Screen (100 Mesh)	16.25
41-2628	14-346	Filter Element - .009 Screen (60 Mesh)	—
41-2629	14-347	Filter Element - .012 Screen (50 Mesh)	21.35
41-2739	20-644	Packing Kit - Economy	—
41-2828	2-336	Teflon V-Packing	6.10
41-2854	1-665	Leather V-Packing	6.10
41-9613	20-1280	Lower Packing Set - Hornet / Wasp	—
41-9614	20-1281	Upper Packing Set - Hornet / Wasp	—
41-9617	10-948	Seal	—
41-9628	18-945	Male Adapter	—
41-9630	18-943	Female Adapter	—
41-9631	1-908	Leather V-Packing	—
41-9632	2-884	Teflon V-Packing	—
41-9633	18-944	Male Adapter	—
41-9634	18-946	Female Adapter	—
41-9635	1-909	Leather V-Packing	—
41-9636	2-885	Teflon V-Packing	—
41-9639	6-950	Tube Seal	—
41-9646	6-949	Valve Seal	—
41-9656	20-952	Kit - Hornet / Wasp	—
41-9695	6-1352	Seal	—
41-9712	10-332	Gasket	—

BINKS LIST PRICES ARE BASED ON SINGLE UNIT PRICE IN BINKS U.S. PRICE LIST DATED 1/11/11

BEDFORD® Replacement Parts For . . . BINKS Equipment

To order, contact your local
Paint Spray Equipment Dealer and ask for
Genuine Bedford Replacement Parts.

REPLACES BINKS PART NO.	BEDFORD PART NO.	DESCRIPTION	BINKS LIST PRICE (\$)
41-9718	10-947	Gasket	—
41-9728	18-1128	Male Adapter	—
41-9729	18-1129	Female Adapter	—
41-9731	6-1127	Tube Seal	—
41-9736	18-1130	Female Adapter	—
41-9737	1-911	Leather V-Packing	—
41-9738	2-886	Teflon V-Packing	—
41-9739	18-1131	Male Adapter	—
41-9745	20-1132	Kit - Super Hornet	—
41-9788	20-1432	Upper Packing Set - Super Hornet	—
41-9791	20-1433	Lower Packing Set - Super Hornet	—
41-10069	6-334	Gasket	3.05
41-10074	20-376	Upper Packing Set - Super Bee	—
41-10075	18-661	Female Adapter	—
41-10076	18-660	Male Adapter	—
41-10079	20-377	Lower Packing Set - Super Bee	—
41-10080	18-663	Female Adapter	—
41-10083	18-662	Male Adapter	—
41-10084	58-1941	Piston Seat Assembly - Super Bee	—
41-10090	10-593	Gasket	—
41-10091	57-1000	Pump Rod - Super Bee	—
41-10094	14-674	Inlet Strainer - 3/4" NPT Thread	21.35
41-10149	8-1108	Gasket	—
41-10275	58-1892	Lower Ball Seat - Super Bee	87.30
41-10285	20-639	Packing Set - "B"	—
41-10320	20-375	Kit - Super Bee	—
41-12669	1-214	Leather V-Packing	—
41-12703	57-1462	Rod - Humdinger	—
41-12711	18-326	Male Adapter	—
41-12715	18-532	Male Adapter	—
41-12718	8-1070	Gasket	—
41-12720	8-1069	Gasket	—
41-12722	8-1067	Gasket	—
41-12795	58-1893	Lower Ball Seat - Humdinger	—
41-12815	20-1092	Kit - Humdinger	—
41-12818	18-210	Female Adapter	—
41-12819	18-213	Female Adapter	—
41-12820	2-220	Teflon V-Packing	—
41-12821	2-531	Teflon V-Packing	—
41-12822	20-533	Upper Packing Set - Humdinger	—
41-12823	20-566	Lower Packing Set - Humdinger	—
54-304	23-777	Spring	1.63
54-722	7-1052	Wiper Cup	1.48
54-723	10-745	Gasket	.82
54-728	23-775	Spring	1.63
54-736	23-779	Spring	—
54-738	7-778	Packing	1.02
54-739	8-182	Gasket	5.10
54-744	47-363	Stem	7.90
54-747	7-755	Packing	1.02
54-749	8-951	Gasket	1.02
54-750	23-773	Spring	1.43
54-759	44-176	Screw	6.35
54-760	44-178	Stud	5.85
54-764	10-764	Packing, graphite	—

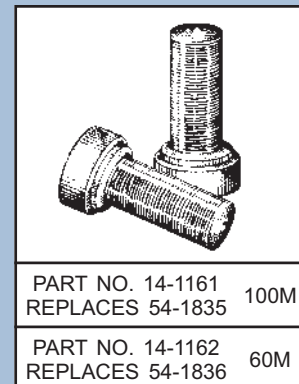

BINKS LIST PRICES ARE BASED ON SINGLE UNIT PRICE IN BINKS U.S. PRICE LIST DATED 1/11/11

To order, contact your local
Paint Spray Equipment Dealer and ask for
Genuine Bedford Replacement Parts.

BEDFORD® Replacement Parts For . . . BINKS Equipment

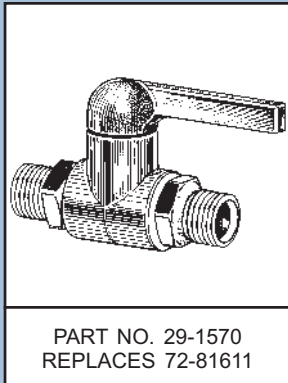
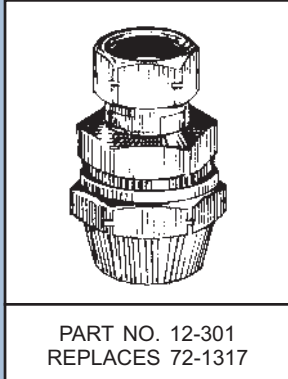

REPLACES BINKS PART NO.	BEDFORD PART NO.	DESCRIPTION	BINKS LIST PRICE (\$)
54-918	8-701	Gasket	1.17
54-1014	44-1045	Pin	1.02
54-1020	44-215	Stud	5.10
54-1025	47-364	Stem	7.90
54-1347	23-248	Spring	1.48
54-1439	8-830	Gasket	5.10
54-1697	23-1043	Spring	7.15
54-1734	44-1046	Pin	—
54-1735	7-1018	Packing	—
54-1835	14-1161	Tip Filter, 100 Mesh, Fine	18.55
54-1836	14-1162	Tip Filter, 60 Mesh, Coarse	18.55
54-2066	7-757	Packing	—
54-2229	8-649	Gasket	2.09
54-3512	47-1877	Spindle Assembly - Mach I / BBR	14.75
54-3518	23-1878	Spring, Blue	5.10
54-3520	23-1879	Spring, Yellow	5.10
54-3577	20-2154	Kit - Model 95 Gun	26.40
54-3605	20-1880	Kit - Mach I / BBR Gun	25.40
54-3710	10-1845	Packing Gland	—
54-3729	6-2331	Seal	4.10
54-3919	—	Order as: (1) 54-1020 & (1) 82-126	—
54-3980	20-2340	Kit - BBR & Mach 1A Automatic Guns	11.20
54-4225	20-2080	Kit - #95 Gun Fluid Inlet	—
54-4226	20-2155	Spindle Kit - Model 95 Gun	27.45
54-4261	20-1960	Needle Packing Kit - Mach I / BBR	6.60
54-4263	12-1959	Packing Nut	5.10
54-4264	4-1954	Adapter	4.10
54-4265	4-1955	Needle Seal	4.10
54-4266	10-1957	Seal, Backup	4.10
54-4267	23-1958	Spring	5.10
55-30	54-29	Cup Lid Gasket	3.05
56-730	54-32	Cup Lid Gasket	—
58-266	44-174	Stud, Trigger	—
71-28	12-227	Brass Nipple 1/8" NPT x 1/4" NPS	4.10
71-130	13-64	1/4" Red Smooth Air Hose, Cut Length	1.04
71-131	13-79	5/16" Red Smooth Air Hose, Cut Length	1.22
71-132	13-66	3/8" Red Air Hose, Cut Length	1.29
71-280	13-470	1/4" Fluid Hose, Full Reel (per foot)	1.73
71-282	13-480	3/8" Fluid Hose, Full Reel (per foot)	2.08
71-283	13-1010	1/2" Fluid Hose, Full Reel (per foot)	3.23
71-1103	13-520	15' x 1/4" Air Hose Assembly	—
71-1105	13-521	25' x 1/4" Air Hose Assembly	50.75
71-1106	13-522	50' x 1/4" Air Hose Assembly	83.25
71-1107	13-523	75' x 1/4" Air Hose Assembly	—
71-1108	13-524	100' x 1/4" Air Hose Assembly	—
71-1203	13-366	15' x 5/16" Air Hose Assembly	37.60
71-1205	13-354	25' x 5/16" Air Hose Assembly	50.75
71-1206	13-355	50' x 5/16" Air Hose Assembly	84.25
71-1207	13-356	75' x 5/16" Air Hose Assembly	—
71-1208	13-357	100' x 5/16" Air Hose Assembly	—
71-1303	13-529	15' x 3/8" Air Hose Assembly	—
71-1305	—	Replaced by 71-1355 (13-525)	—
71-1306	—	Replaced by 71-1356 (13-526)	—
71-1307	13-527	75' x 3/8" Air Hose Assembly	—
71-1308	13-528	100' x 3/8" Air Hose Assembly	—

BINKS LIST PRICES ARE BASED ON SINGLE UNIT PRICE IN BINKS U.S. PRICE LIST DATED 1/11/11

BEDFORD® Replacement Parts For . . . BINKS Equipment

To order, contact your local
Paint Spray Equipment Dealer and ask for
Genuine Bedford Replacement Parts.

REPLACES BINKS PART NO.	BEDFORD PART NO.	DESCRIPTION	BINKS LIST PRICE (\$)
71-1355	13-525	25' x 3/8" Air Hose Assembly	56.85
71-1356	13-526	50' x 3/8" Air Hose Assembly	106.60
71-3302	13-485	15' x 3/8" Fluid Hose Assembly	—
71-3303	13-481	25' x 3/8" Fluid Hose Assembly	80.20
71-3304	13-482	50' x 3/8" Fluid Hose Assembly	143.15
71-3305	13-483	75' x 3/8" Fluid Hose Assembly	—
71-3306	13-484	100' x 3/8" Fluid Hose Assembly	—
71-3322	13-1015	15' x 1/2" Fluid Hose Assembly	—
71-3323	13-1011	25' x 1/2" Fluid Hose Assembly	—
71-3324	13-1012	50' x 1/2" Fluid Hose Assembly	—
71-3325	13-1013	75' x 1/2" Fluid Hose Assembly	—
71-3326	13-1014	100' x 1/2" Fluid Hose Assembly	—
71-3382	13-475	15' x 1/4" Fluid Hose Assembly	—
71-3383	13-471	25' x 1/4" Fluid Hose Assembly	68.05
71-3384	13-472	50' x 1/4" Fluid Hose Assembly	128.95
71-3385	13-473	75' x 1/4" Fluid Hose Assembly	—
71-3386	13-474	100' x 1/4" Fluid Hose Assembly	—
71-7704	13-931	25' x 1/4" Airless Hose Assembly	95.45
71-7705	13-932	50' x 1/4" Airless Hose Assembly	175.60
71-8085	13-798	5' x 3/16" Airless Hose Assembly	48.75
71-8086	13-794	10' x 3/16" Airless Hose Assembly	—
71-8087	13-795	15' x 3/16" Airless Hose Assembly	—
71-8088	13-796	25' x 3/16" Airless Hose Assembly	102.55
71-8089	13-797	50' x 3/16" Airless Hose Assembly	188.80
71-8424	13-451	25' x 3/8" Airless Hose Assembly	139.10
71-8425	13-453	50' x 3/8" Airless Hose Assembly	292.35
71-9130	—	Replaced by 71-10000 (13-4)	—
71-9131	—	Replaced by 71-11000 (13-59)	—
71-9132	—	Replaced by 71-12000 (13-6)	—
71-9280	—	Replaced by 71-280 (13-470)	—
71-9282	—	Replaced by 71-282 (13-480)	—
71-9283	—	Replaced by 71-283 (13-1010)	—
71-9284	—	Replaced by 71-284 (13-490)	—
71-10000	13-4	1/4" Red Air Hose, Full Reel (per foot)	1.04
71-11000	13-59	5/16" Red Smooth Air Hose, Full Reel (per ft)	1.22
71-12000	13-6	3/8" Red Smooth Air Hose, Full Reel (per ft)	1.29
72-54	12-1225	Adapter 3/8" NPS(m) x 1/4" NPS(f)	12.20
72-55	12-599	Adapter 1/4" NPS(m) x 3/8" NPS(f)	6.10
72-918	12-201	Swivel Adapter 1/4" NPT(f) x 1/4" NPS(f)	23.35
72-945	12-406	Swivel Adapter 3/8" NPT(m) x 1/2" NPS(f)	—
72-995	12-229	Nipple 1/4" NPT x 3/8" NPT	—
72-1303	12-304	1/4" Hose Fitting x 1/4" NPS(f)	4.60
72-1306	12-306	1/4" Hose Fitting x 3/8" NPS(f)	5.10
72-1317	12-301	5/16" Hose Fitting x 1/4" NPS(f)	5.10
72-1325	12-303	3/8" Hose Fitting x 1/4" NPS(f)	6.10
72-1328	12-302	3/8" Hose Fitting x 3/8" NPS(f)	6.10
72-1333	12-368	1/2" Hose Fitting x 3/8" NPS(f)	12.20
72-1478	12-305	5/16" Hose Fitting x 1/4" NPT(m)	6.10
72-81212	29-2375	Ball Valve, 3/8" NPT x 3/8" NPT, 250 PSI	40.60
72-81216	29-1693	Ball Valve, 3/8" NPT x 1/4" NPS, 250 PSI	40.60
72-81611	29-1570	Ball Valve, 1/4" NPS x 1/4" NPT, 250 PSI	40.60
72-81612	29-1672	Ball Valve, 1/4" NPS x 3/8" NPT, 250 PSI	40.60
72-81711	29-1694	Ball Valve, 3/8" NPS x 1/4" NPT, 250 PSI	40.60
72-81712	29-1571	Ball Valve, 3/8" NPS x 3/8" NPT, 250 PSI	40.60
72-83030	29-2575	Ball Valve, 1/4" NPT x 1/4" NPT, 250 PSI	40.60

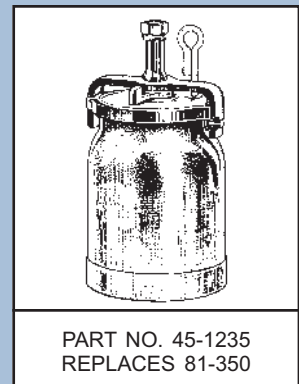
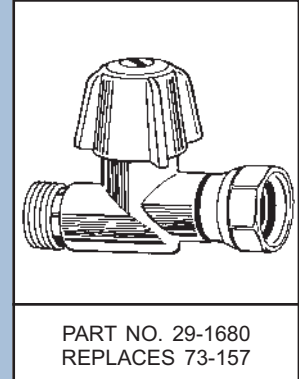

BINKS LIST PRICES ARE BASED ON SINGLE UNIT PRICE IN BINKS U.S. PRICE LIST DATED 1/11/11

To order, contact your local
Paint Spray Equipment Dealer and ask for
Genuine Bedford Replacement Parts.

BEDFORD® Replacement Parts For . . . BINKS Equipment

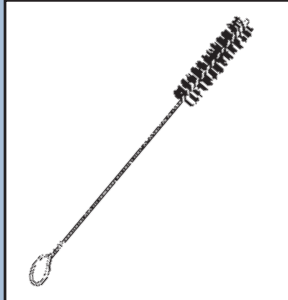

PART NO. 53-1101
REPLACES 82-469

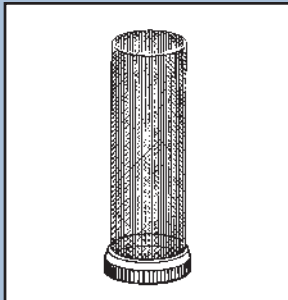

PART NO. 14-1734
REPLACES 83-1256

REPLACES BINKS PART NO.	BEDFORD PART NO.	DESCRIPTION	BINKS LIST PRICE (\$)
72-84030	29-2601	Ball Valve, 1/4" NPT x 3/8" NPT, 250 PSI	50.75
72-84040	29-2576	Ball Valve, 3/8" NPT x 3/8" NPT, 250 PSI	40.60
73-9	7-1384	Gasket	1.02
73-42	47-1664	Body Assembly	—
73-43	44-1665	Stem	—
73-44	12-1666	Nut	—
73-46	46-1669	Cap	—
73-157	29-1680	Metering ("Cheater") Valve	15.25
80-11	54-81	Cup Lid Gasket, White Plastic	3.25
80-45	54-45	Cup Gasket, Leather	—
81-304	13-918	Tube	2.24
81-307	12-971	Connector, Nylon	3.05
81-350	45-1235	Cup Assembly - Non-Drip	—
81-352	47-1232	Centerpost	41.65
81-354	46-1228	Lever	—
81-355	46-1229	Cover	—
81-357	17-1231	Yoke	—
81-550	45-1255	Cup Assembly - Standard	—
81-552	44-1227	Vent	—
82-47	45-899	Quart Cup	—
82-55	44-912	Nut	—
82-56	54-55	1-Quart Cup Lid Gasket, White Foam	3.05
82-126	44-175	Screw	1.63
82-158	7-749	Packing	.66
82-368	8-1226	Washer, Nylon	2.03
82-467	54-7	Gasket	1.63
82-469	53-1101	Round Brush, 9/16"	3.05
83-576	12-222	Brass Nipple 1/4" NPS x 1/4" NPT	5.10
83-1050	12-221	Brass Nipple 1/4" NPS x 1/4" NPS	23.35
83-1256	14-1734	Filter Element, 100 Mesh	9.15
83-1294	12-223	Brass Nipple 3/8" NPS x 3/8" NPS	7.15
83-1419	56-90	Tank Lid Gasket, 2 Gallon, Stratoprene	21.50
83-1419-T	56-19	Tank Lid Gasket, 2 Gallon, Thiokol	—
83-1420	56-91	Tank Lid Gasket, 5 Gallon, Stratoprene	36.55
83-1421	56-92	Tank Lid Gasket, 10 & 15 Gallon, Stratoprene	—
83-1876	29-1676	ASME Air Relief Safety Valve - 80 PSI	—
83-1879	29-941	Air Safety Valve - 110 PSI	42.65
83-1935	12-409	Swivel Adapter 1/4" NPT(f) x 1/4" NPS(f)	13.20
83-2089	14-1732	Filter Element, 50 Mesh	11.20
83-2405	14-1735	Filter Element, 150 Mesh	15.25
83-2429	29-1677	ASME Air Relief Safety Valve - 80 PSI	53.30
83-2596	14-1733	Filter Element, 80 Mesh	16.25
83-2600	6-982	Teflon Seal	1.02
83-2621	20-1601	1/4" NPS(m) Fitting for Ball Valve	—
83-2622	20-1602	3/8" NPS(m) Fitting for Ball Valve	—
83-2623	20-1603	1/4" NPT(m) Fitting for Ball Valve	—
83-2635	20-1604	3/8" NPT(m) Fitting for Ball Valve	—
83-2705	14-1731	Filter Element, 30 Mesh	17.30
83-2706	14-1736	Filter Element, 200 Mesh	17.30
83-2727	28-759	Gauge, 0-100 PSI (Functionally equal)	20.30
85-53	23-1044	Spring	—
85-70	28-1358	Gauge, 1/8" NPT Btm Mnt, 0-60 PSI, 1-1/2"	21.35
86-558	12-1481	Plug, 1/4" NPT	5.10
101-1147	10-1390	Washer	6.10
101-6509	2-1016	Teflon V-Packing	—

BINKS LIST PRICES ARE BASED ON SINGLE UNIT PRICE IN BINKS U.S. PRICE LIST DATED 1/11/11

BEDFORD® Replacement Parts For . . . DEVILBISS Equipment

To order, contact your local
Paint Spray Equipment Dealer and ask for
Genuine Bedford Replacement Parts.

REPLACES DEVILBISS PART NO.	BEDFORD PART NO.	DESCRIPTION	DEVILBISS LIST PRICE (\$)
23165-001-K10	55-2349	O-Rings (Kit of 10)	30.50
42884-214-K5	55-1176	Cleaning Brushes, 3/8" Dia (Kit of 5)	16.75
42884-215-K10	55-1177	Cleaning Brushes, 5/8" Dia (Kit of 10)	29.95
A-23-K10	55-1906	Packings (Kit of 10)	17.30
A-42-K5	55-367	Screws (Kit of 5)	—
AD-31	12-221	Brass Nipple 1/4" NPS x 1/4" NPS	7.15
AD-404	12-599	Adapter 1/4" NPS(m) x 3/8" NPS(f)	7.15
AV-1-K5	55-1048	Gaskets (Kit of 5)	6.35
C-39-K5	55-71	Cup Gaskets (Kit of 5)	—
CV-5-K5	55-1055	Gaskets (Kit of 5)	7.90
GA-92	28-1358	Gauge, 1/8" NPT Btm Mnt, 0-60 PSI, 1-1/2"	—
GA-100	—	Functionally Equivalent to GA-333 Gauge	—
GA-211	28-719	Gauge, 1/4" NPT Btm Mnt, 0-200 PSI, 2"	—
GA-288	28-766	Gauge, 1/4" NPT Btm Mnt, 0-160 PSI, 2"	21.35
GA-316	28-705	Gauge, 1/4" NPT Rear Mnt, 0-160 PSI, 2"	34.55
GA-333	28-759	Gauge, 1/4" NPT Btm Mnt, 0-100 PSI, 2"	—
GC-25-K5	55-76	Cup Gaskets (Kit of 5)	—
H-77	12-879	Brass Nipple 3/8" NPS x 5/8"-18	—
H-153	12-878	Brass Nipple 1/4" NPS x 5/8"-18	—
H-1446	12-223	Brass Nipple 3/8" NPS x 3/8" NPS	5.10
H-1766	12-227	Brass Nipple 1/8" NPT x 1/4" NPS	6.10
H-1901	—	Replaced by Binks 71-11000 (13-59)	—
H-1921	—	Replaced by Binks 71-11000 (13-59)	—
H-1957	13-4	Replaced by Binks 71-10000 (13-4)	1.04
H-1957	—	Replaced by Binks 71-10000 (13-4)	—
H-1958	—	Replaced by Binks 71-12000 (13-6)	—
H-1973-1	—	Replaced by Binks 71-282 (13-480)	—
H-1974-1	—	Replaced by Binks 71-283 (13-1010)	—
H-1975-1	—	Replaced by Binks 71-280 (13-470)	—
H-2008	12-222	Brass Nipple 1/4" NPS x 1/4" NPT	6.10
H-4326	12-413	Swivel Adapter 3/8" NPT(f) x 3/8" NPS(f)	—
HA-0125	13-358	25' x 5/16" Air Hose Assembly (Corrugated)	—
HA-0150	13-359	50' x 5/16" Air Hose Assembly (Corrugated)	—
HA-2125	13-354	25' x 5/16" Air Hose Assembly (Smooth)	—
HA-2150	13-355	50' x 5/16" Air Hose Assembly (Smooth)	—
HA-7325	13-481	25' x 3/8" Fluid Hose Assembly	—
HA-7350	13-482	50' x 3/8" Fluid Hose Assembly	—
HA-7525	13-471	25' x 1/4" Fluid Hose Assembly	—
HAR-502	26-2328	Regulator, 1/4" for Series Installations	—
HAR-505	26-1125	Regulator, 1/4" General Purpose	—
HAR-555	26-1119	Regulator, 3/8" x 1/2" for Series Installations	79.20
HAV-500	29-1680	Functionally Equivalent to Binks 73-157	15.25
JGA-7-K5	—	Replaced by JGA-4035-K5 (55-2355)	—
JGA-14-K25	55-2350	Snap Rings (Kit of 25)	—
JGA-15-K25	55-2354	Washers (Kit of 25)	—
JGA-35-K5	55-1098	Trigger Bearing Studs (Kit of 5)	—
JGA-4035-K5	55-2355	Valve Packings (Kit of 5 Sets)	20.30
JGD-14-K10	55-1908	Gaskets (Kit of 10)	16.75
JGHV-116-K5	55-1963	Gaskets (Kit of 5)	—
JGS-26-K5	55-1139	U-Cups (Kit of 5)	—
JGS-35	—	See JGS-478 Kit (20-2268)	—
JGS-72-K10	55-913	Gaskets (Kit of 10)	12.75
JGS-431-K25	55-2356	Air Valve Assembly (Kit of 25)	205.30
JGS-449-1	20-1786	Air Valve Assembly	33.50
JGS-478	20-2268	Kit - (3) Trigger Studs & (5) Screws	—

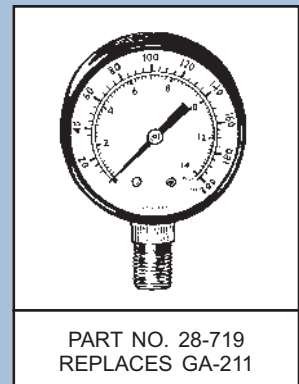
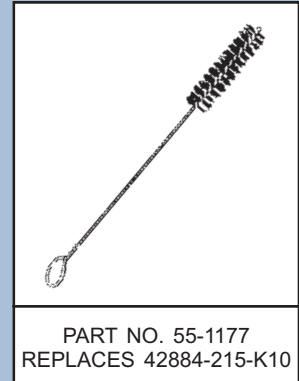

DEVILBISS LIST PRICES ARE BASED ON SINGLE UNIT PRICE IN DEVILBISS U.S. PRICE LIST DATED 1/1/11

To order, contact your local
Paint Spray Equipment Dealer and ask for
Genuine Bedford Replacement Parts.

BEDFORD® Replacement Parts For . . . DEVILBISS Equipment



PART NO. 26-2328
REPLACES HAR-502

PART NO. 26-1125
REPLACES HAR-505

PART NO. 26-1119
REPLACES HAR-555

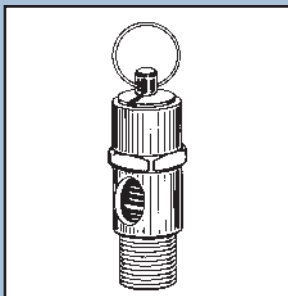

PART NO. 29-941
REPLACES TIA-5110

REPLACES DEVILBISS PART NO.	BEDFORD PART NO.	DESCRIPTION	DEVILBISS LIST PRICE (\$)
KK-4058-1	20-1146	Kit - MBC Spray Gun	40.10
KK-4059	—	Replaced by KK-4987-2 (20-2055)	—
KK-4138	24-1024	T-Handle & Cage - Gen'l Purpose Regulator	26.40
KK-4139	—	Functionally equivalent to KK-4167	—
KK-4167	24-1126	Repair Kit for General Purpose Regulators	—
KK-4830	—	Replaced by KK-4987-2 (20-2055)	—
KK-4911	20-1596	Kit - HVLP Spray Gun	—
KK-4987-2	20-2055	Kit - JGA, JGV, JGP, JGPV, MSA, MSV	27.45
KR-11-K5	55-74	Cup Gaskets (Kit of 5)	60.92
KR-69-K5	55-72	Cup Gaskets (Kit of 5)	—
MB-16	44-1091	Stud, Trigger Bearing	—
MB-26-K5	55-1134	Packings (Kit of 5)	—
MB-135-K9	55-1159	Needle Valve Packings (Kit of 9)	9.90
MBC-28-K5	55-902	Springs (Kit of 5)	—
MBC-29-K5	55-895	Springs (Kit of 5)	—
MBC-62-K5	55-1135	Packings (Kit of 5)	25.50
MBC-70-K2	55-1136	Needle Springs (Kit of 2)	10.15
MBC-1226-K10	55-1097	Gaskets (Kit of 10)	20.85
MBD-12-K25	55-2357	Springs (Kit of 25)	57.10
MBD-14-K10	55-1152	Packing Washers (Kit of 10)	—
MBD-19-K10	55-1909	Springs (Kit of 10)	22.60
MBD-25-K5	55-1172	Springs (Kit of 5)	—
MSV-3-K10	55-2259	Fluid Inlet Gaskets (Kit of 10)	16.00
P-H-4105	12-1225	Adapter 3/8" NPS(m) x 1/4" NPS(f)	5.10
P-H-5516	—	Functionally Equivalent to Binks 73-157 Valve	—
P-HC-4523	12-304	1/4" Hose Fitting x 1/4" NPS(f)	—
P-HC-4527	12-301	5/16" Hose Fitting x 1/4" NPS(f)	—
P-HC-4528	12-303	3/8" Hose Fitting x 1/4" NPS(f)	—
P-HC-4543	12-306	1/4" Hose Fitting x 3/8" NPS(f)	—
P-HC-4548	12-302	3/8" Hose Fitting x 3/8" NPS(f)	—
P-HC-4551	12-368	1/2" Hose Fitting x 3/8" NPS(f)	—
P-HC-4599	12-305	5/16" Hose Fitting x 1/4" NPT(m)	—
PT-33-1	56-97	Tank Lid Gasket, 2-1/2 Gallon, Stratoprene	19.30
QM-1458-1	56-98	Tank Lid Gasket, 5 & 15 Gallon, Stratoprene	33.50
QM-1462	56-93	Tank Lid Gasket, 2 Gallon, Stratoprene	—
QMS-67	56-94	Tank Lid Gasket, 2 Gallon, Stratoprene	—
QMS-80-1	56-95	Tank Lid Gasket, 2-1/2 Gallon, Stratoprene	35.55
QN-96	56-96	Tank Lid Gasket, 2 Gallon, Rubber	—
QS-100	10-1652	Oil Seal	—
SS-1215	12-1480	Plug, 1/8" NPT	—
SS-1216	12-1481	Plug, 1/4" NPT	—
SS-1217	12-1483	Plug, 3/8" NPT	—
SS-7312-K5	55-1164	Gaskets (Kit of 5)	—
SSG-8069-K25	55-2358	O-Rings (Kit of 25)	31.25
SSG-8182-K5	55-1961	O-Rings (Kit of 5)	5.60
SSP-3-CD	12-465	Swivel Adapter, 1/2" NPT(m) x 1/2" NPS(f)	—
SSP-7-CD	12-405	Swivel Adapter, 3/8" NPT(m) x 3/8" NPS(f)	—
SSP-14-CD	12-403	Swivel Adapter, 1/4" NPT(m) x 3/8" NPS(f)	—
SSP-25-CD	12-404	Swivel Adapter, 3/8" NPT(m) x 1/4" NPS(f)	—
SST-8405-K5	55-1140	Retaining Rings (Kit of 5)	—
SST-8434	19-1741	Retaining Ring	—
TGC-9-K5	55-87	Gaskets (Kit of 5)	18.30
TIA-5080	29-1676	ASME Air Relief Safety Valve - 80 PSI	33.50
TIA-5110	29-941	ASME Air Relief Safety Valve - 110 PSI	32.50

DEVILBISS LIST PRICES ARE BASED ON SINGLE UNIT PRICE IN DEVILBISS U.S. PRICE LIST DATED 1/1/11

BEDFORD® Replacement Parts For . . . GRACO Equipment

To order, contact your local
Paint Spray Equipment Dealer and ask for
Genuine Bedford Replacement Parts.

REPLACES GRACO PART NO.	BEDFORD PART NO.	DESCRIPTION	GRACO LIST PRICE (\$)
061-089	13-6	3/8" Red Smooth Air Hose, Reel, 250 PSI	—
061-204	13-4	1/4" Red Smooth Air Hose, Reel, 250 PSI	—
061-207	13-59	5/16" Red Smooth Air Hose, Reel, 250 PSI	—
070-289	22-2771	Sealant	3.70
100-040	12-1483	Plug, 3/8" NPT	4.20
100-063	19-258	Pin	3.25
100-064	9-630	Ball	3.25
100-065	9-657	Ball	3.25
100-069	9-255	Ball	3.25
100-084	9-690	Ball	5.80
100-103	19-391	Cotter Pin	3.25
100-114	9-610	Ball	3.25
100-148	9-691	Ball	3.20
100-279	9-127	Ball	9.00
100-332	9-693	Ball	3.75
100-400	9-669	Ball	4.45
100-403	12-1480	Plug, 1/8" NPT	3.95
100-454	19-1618	Screw	3.25
100-509	12-1481	Plug, 1/4" NPT	3.50
100-721	12-1482	Plug, 1/4" NPT with Hex Socket End	7.90
100-846	12-1309	Grease Fitting	3.20
100-960	28-719	Gauge, 1/4" NPT Btm Mnt, 0-200 PSI, 2"	18.90
101-178	9-128	Ball	24.70
101-190	9-617	Ball	11.70
101-201	12-368	1/2" Hose Fitting x 3/8" NPS(f)	—
101-274	19-392	Cotter Pin	3.25
101-391	19-1248	Pin	6.10
101-454	9-1239	Ball	—
101-545	19-393	Cotter Pin	3.25
101-701	9-1554	Ball	13.20
101-718	9-1258	Ball	64.00
101-750	9-883	Ball	13.60
101-822	9-995	Ball	8.05
101-823	9-129	Ball	7.20
101-859	9-996	Ball	8.40
101-874	9-130	Ball	7.10
101-890	19-763	Screw	3.25
101-891	53-1093	Brush, 3/8" Diameter	9.30
101-892	53-1096	Brush, 5/8" Diameter	8.70
101-917	9-153	Ball	15.10
101-946	19-394	Cotter Pin	3.25
101-947	9-244	Ball	3.90
101-956	9-245	Ball	3.25
101-968	9-695	Ball	63.25
102-119	9-1895	Ball	5.30
102-233	9-897	Ball	3.90
102-310	19-1393	Nut	5.90
102-366	19-461	Screw	—
102-413	43-1249	Packing	26.90
102-416	43-1250	Packing	40.40

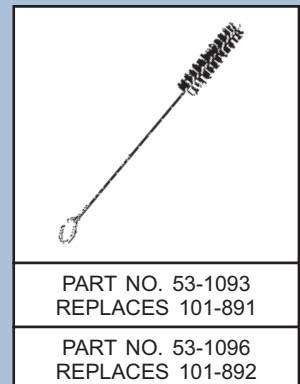
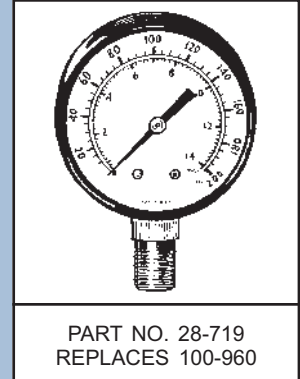

GRACO LIST PRICES ARE BASED ON SINGLE UNIT PRICE IN GRACO U.S. PRICE LIST DATED 1/4/11

To order, contact your local
Paint Spray Equipment Dealer and ask for
Genuine Bedford Replacement Parts.

BEDFORD® Replacement Parts For . . . GRACO Equipment

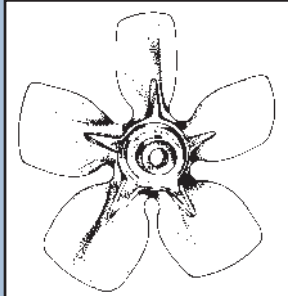

PART NO. 17-1236
REPLACES 102-654

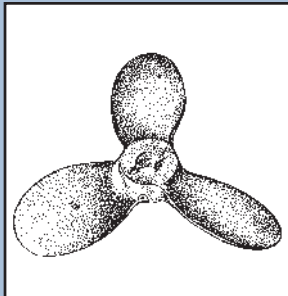

PART NO. 46-1062
REPLACES 159-854

REPLACES GRACO PART NO.	BEDFORD PART NO.	DESCRIPTION	GRACO LIST PRICE (\$)
102-417	43-1251	Packing	36.40
102-418	43-1252	Packing	—
102-596	15-818	Teflon O-Ring	16.80
102-642	—	Replaced by 106-260 (15-1695)	—
102-654	17-1236	Impeller	89.25
102-659	11-824	Packing	—
102-727	0-668	O-Ring	59.00
102-861	0-1063	O-Ring	8.55
102-867	0-1053	O-Ring	40.50
102-930	0-1064	O-Ring	22.80
102-952	—	Replaced by 181-073 (14-1224)	—
102-969	22-592	Adhesive	3.90
102-972	9-839	Ball	11.00
102-973	9-692	Ball	26.50
102-974	9-1747	Ball	136.50
103-185	0-1040	O-Ring	9.05
103-186	6-862	Backup Ring	—
103-337	0-836	O-Ring	3.00
103-413	0-2741	O-Ring	1.30
103-605	12-301	5/16" Hose Fitting x 1/4" NPS(f)	8.80
103-648	0-877	O-Ring	5.80
103-740	48-972	Switch - EM400	—
104-084	12-306	1/4" Hose Fitting x 3/8" NPS(f)	6.40
104-319	15-2862	Teflon O-Ring	6.00
104-361	15-432	Teflon O-Ring	12.80
104-412	12-310	Compression Ring for 1/4" Hose Fittings	1.70
104-413	12-312	Compression Ring for 3/8" Hose Fittings	.90
104-414	12-302	3/8" Hose Fitting x 3/8" NPS(f)	8.25
104-415	12-304	1/4" Hose Fitting x 1/4" NPS(f)	5.80
104-445	0-1106	Packing	13.10
104-537	15-2640	Teflon O-Ring	9.60
104-804	15-1434	Teflon O-Ring	6.50
104-892	15-1057	Teflon O-Ring	4.00
104-893	15-1058	Teflon O-Ring	3.15
104-928	—	Replaced by 156-082 (0-597)	—
104-938	0-1847	O-Ring	6.85
104-951	—	Replaced by 170-708 (43-829)	—
105-252	24-1969	Mounting Bracket, Gen'l Purpose Regulator	20.90
105-444	9-140	Ball	3.15
105-445	9-183	Ball	2.90
105-522	43-1253	Seal	12.80
106-093	10-1317	Washer	2.65
106-260	15-1695	Teflon O-Ring	8.70
106-556	0-2333	O-Ring	9.50
107-079	15-2278	Teflon O-Ring	2.65
107-082	0-1238	O-Ring	6.40
107-093	43-1254	Seal	14.30
107-098	15-1543	Teflon O-Ring	4.40
107-109	23-1521	Spring	—
107-110	19-1522	Nut	3.25

GRACO LIST PRICES ARE BASED ON SINGLE UNIT PRICE IN GRACO U.S. PRICE LIST DATED 1/4/11

BEDFORD® Replacement Parts For . . . GRACO Equipment

To order, contact your local
Paint Spray Equipment Dealer and ask for
Genuine Bedford Replacement Parts.

REPLACES GRACO PART NO.	BEDFORD PART NO.	DESCRIPTION	GRACO LIST PRICE (\$)
107-167	9-2371	Ball	23.10
107-203	9-2380	Ball	9.85
107-245	—	Replaced by 157-785 (12-408)	—
107-306	0-2379	O-Ring	9.35
107-505	15-2873	Teflon O-Ring	3.25
107-536	9-1975	Ball	5.60
108-266	—	Replaced by 154-771 (0-1383)	—
108-450	19-1261	Cotter Pin	13.00
108-451	49-1353	Polyethylene V-Packing	17.60
108-452	49-1327	Polyethylene V-Packing	18.20
108-453	49-1354	Polyethylene V-Packing	12.30
108-454	49-1380	Polyethylene V-Packing	9.55
108-455	49-1912	Polyethylene V-Packing	8.80
108-456	49-1913	Polyethylene V-Packing	8.80
108-526	15-1498	Teflon O-Ring	6.20
108-690	43-1540	Seal, U-Cup	12.20
108-775	9-1541	Ball	8.55
108-822	15-2248	Teflon O-Ring	3.10
108-832	0-2633	O-Ring	4.20
108-954	15-1512	Teflon O-Ring	3.25
108-958	12-1981	Connector, 45°	14.60
108-982	12-1976	Connector, Push-On	6.30
109-303	2-2291	Teflon V-Packing	11.20
109-451	15-1890	Teflon O-Ring	6.30
109-499	15-2644	Teflon O-Ring	8.30
110-110	22-2315	Sealant	19.00
110-165	—	Replaced by 108-526 (15-1498)	—
110-209	24-1972	Mounting Nut, Mini-Regulator	6.90
110-241	0-1788	O-Ring	3.25
110-242	0-1789	O-Ring	3.25
110-321	24-1968	Mounting Bracket & Nut, Mini-Regulator	9.50
110-700	—	Replaced by 100-846 (12-1309)	—
111-317	19-1977	Retaining Clip	2.40
111-457	15-2861	Teflon O-Ring	6.90
111-599	10-2322	Washer, Flat	1.80
111-600	19-2807	Grooved Pin, 1" Long	2.00
111-603	15-1792	Teflon O-Ring	2.90
111-613	4-2360	Cup Packing	23.10
111-699	—	Replaced by 277-364	—
111-710	0-2364	O-Ring	3.35
111-711	6-2363	Backup Ring	2.40
112-561	43-2688	U-Cup Packing	28.40
112-588	—	Replaced by 108-822 (15-2248)	—
112-589	43-2249	U-Cup Seal	10.60
112-590	17-2907	Plug, Throat Seal	2.15
112-591	1-2250	Leather V-Packing	3.75
112-592	49-2251	Polyethylene V-Packing	3.05
112-593	19-2252	Ball Stop Pin	2.20
112-604	14-2779	Inlet Strainer, 1" NPT, 8 Mesh, Single Screen	10.50
112-721	9-2312	Ball	—

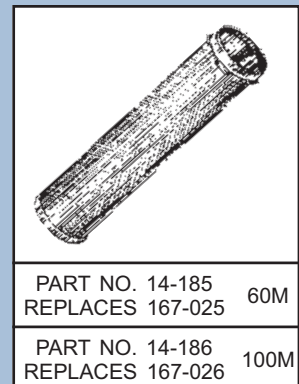
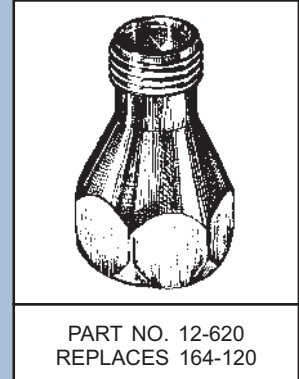

GRACO LIST PRICES ARE BASED ON SINGLE UNIT PRICE IN GRACO U.S. PRICE LIST DATED 1/4/11

To order, contact your local
Paint Spray Equipment Dealer and ask for
Genuine Bedford Replacement Parts.

BEDFORD® Replacement Parts For . . . GRACO Equipment

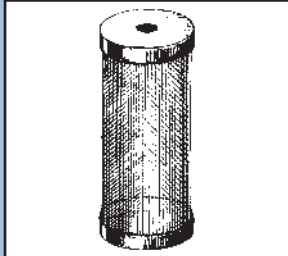

PART NO. 14-193 60M
REPLACES 167-053
PART NO. 14-194 100M
REPLACES 167-054

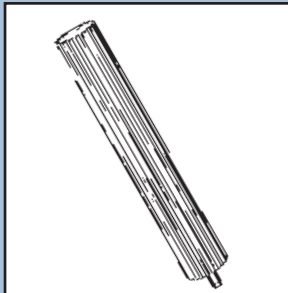

PART NO. 44-1305
REPLACES 171-939

REPLACES GRACO PART NO.	BEDFORD PART NO.	DESCRIPTION	GRACO LIST PRICE (\$)
112-722	9-2313	Ball	—
113-406	—	Order as: Bedford 26-1125 Regulator	—
113-423	0-2689	O-Ring	14.70
114-049	0-2656	O-Ring, Pole Extension	1.60
114-054	0-2284	O-Ring	4.65
115-719	0-2920	O-Ring	1.55
117-285	15-2739	Teflon O-Ring	4.05
117-459	0-2597	O-Ring	1.40
117-559	0-2740	O-Ring	2.75
117-828	15-2599	O-Ring, Encapsulated, Outlet Filter	16.20
118-494	0-2657	O-Ring	1.40
118-503	52-2658	Wiper	5.80
118-504	52-2666	Wiper	7.15
118-948	6-2683	Teflon Backup Ring	1.00
119-636	52-2910	Wiper, Piston	4.60
119-799	53-2777	Brush, 3/8" Diameter	5.75
120-777	0-2880	O-Ring, Solvent Resistant	2.80
150-179	3-101	Leather Cup	12.70
150-429	10-1090	Gasket	5.05
150-516	18-636	Male Gland	3.90
150-522	23-625	Spring	3.90
150-540	10-803	Washer	5.20
150-647	10-683	Gasket	4.35
150-670	10-776	Gasket	3.75
151-519	12-1978	Nipple, 1/8" NPT x 1/4" NPT	9.40
154-594	0-1246	O-Ring	1.35
154-662	0-144	O-Ring	7.70
154-771	0-1383	O-Ring	7.40
154-986	12-404	Swivel Adapter 3/8" NPT(m) x 1/4" NPS(f)	—
155-470	12-418	Swivel Adapter 1/2" NPT(m) x 1/2" NPS(f) 90°	17.00
155-570	12-409	Swivel Adapter 1/4" NPT(f) x 1/4" NPS(f)	11.30
155-665	12-405	Swivel Adapter 3/8" NPT(m) x 3/8" NPS(f)	7.60
155-685	0-1107	Packing	4.40
155-865	12-412	Swivel Adapter 1/2" NPT(f) x 1/2" NPS(f)	14.20
156-082	0-597	O-Ring	6.75
156-172	12-413	Swivel Adapter 3/4" NPT(f) x 3/4" NPS(f)	33.80
156-173	12-251	Swivel Adapter 3/8" NPT(f) x 3/8" NPS(f)	9.15
156-401	0-2433	O-Ring	8.35
156-454	0-330	O-Ring	4.00
156-589	12-415	Swivel Adapter 3/4" NPT(f) x 3/4" NPS(f) 90°	19.50
156-593	0-957	O-Ring	7.15
156-633	0-139	O-Ring	7.40
156-641	0-102	O-Ring	7.40
156-684	12-465	Swivel Adapter 1/2" NPT(m) x 1/2" NPS(f)	32.60
156-698	0-103	O-Ring	5.10
156-766	10-1424	Gasket	3.70
156-811	3-253	Leather Cup	15.50
156-823	12-402	Swivel Adapter 1/4" NPT(m) x 1/4" NPS(f)	6.30
156-849	12-230	Nipple 3/8" NPT x 3/8" NPT	8.40
156-971	12-228	Nipple 1/4" NPT x 1/4" NPT	2.85

GRACO LIST PRICES ARE BASED ON SINGLE UNIT PRICE IN GRACO U.S. PRICE LIST DATED 1/4/11

BEDFORD® Replacement Parts For . . . GRACO Equipment

To order, contact your local
Paint Spray Equipment Dealer and ask for
Genuine Bedford Replacement Parts.

REPLACES GRACO PART NO.	BEDFORD PART NO.	DESCRIPTION	GRACO LIST PRICE (\$)
157-127	10-1264	Gasket	4.40
157-195	0-2908	O-Ring, Spacer	8.15
157-250	0-331	O-Ring	10.50
157-277	0-694	O-Ring	15.00
157-350	12-229	Nipple 1/4" NPT x 3/8" NPT	8.20
157-416	12-431	Swivel Adapter 1/2"NPT(f) x 1/2"NPS(f) 90°	14.00
157-628	0-142	O-Ring	3.05
157-630	23-1646	Spring	5.30
157-633	23-1647	Spring	12.70
157-636	18-398	Female Gland	20.90
157-637	1-104	Leather V-Packing	9.35
157-638	18-397	Male Gland	22.30
157-676	12-201	Swivel Adapter 1/4"NPT(f) x 1/4"NPS(f) 90°	28.20
157-705	12-403	Swivel Adapter 1/4" NPT(m) x 3/8" NPS(f)	8.65
157-785	12-408	Swivel Adapter 3/4" NPT(m) x 3/4" NPS(f)	12.60
157-894	18-635	Female Gland	3.50
158-109	5-105	Rubber Gasket	3.25
158-256	12-407	Swivel Adapter 1/2" NPT(m) x 3/8" NPS(f)	18.00
158-367	16-842	Grommet	6.40
158-377	0-131	O-Ring	7.40
158-378	0-132	O-Ring	30.90
158-379	0-135	O-Ring	21.00
158-402	3-149	Leather Cup	16.70
158-486	0-138	O-Ring	3.45
158-491	12-231	Nipple 1/2" NPT x 1/2" NPT	14.40
158-776	0-2758	O-Ring	9.15
158-882	3-233	Flange Packing	—
159-239	12-232	Nipple 3/8" NPT x 1/2" NPT	10.70
159-308	11-584	V-Packing	13.70
159-312	18-1041	Male Gland	25.80
159-314	1-150	V-Packing	9.40
159-471	17-1263	Spreader	—
159-854	46-1062	Propeller	29.70
15B-112	15-2598	Teflon O-Ring	1.40
15B-958	0-2703	O-Ring	3.75
15C-987	18-2659	Male Gland	2.65
15C-988	18-2660	Female Gland	2.65
15C-997	10-2661	Backup Washer	2.20
15C-998	10-2669	Backup Washer	2.05
15E-022	58-2317	Seat	6.50
15E-329	1-2718	Leather V-Packing	4.75
15F-183	10-2915	Backup Washer	4.60
15F-875	49-2909	Polyethylene V-Packing	4.90
15G-234	52-2743	Wiper, Piston	3.05
15G-657	18-2911	Female Gland, upper	9.80
15G-658	18-2912	Male Gland, upper	13.30
15J-800	10-2913	Backup Washer	9.25
160-011	3-243	Leather Packing	—
160-015	0-903	O-Ring	12.70
160-020	3-181	Leather Cup	24.40

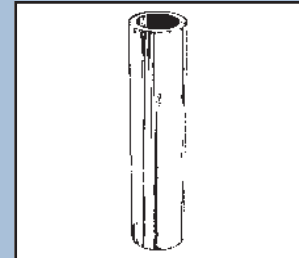

PART NO. 57-1403
REPLACES 178-898

PART NO. 57-1405
REPLACES 178-902



PART NO. 57-1406
REPLACES 178-899

PART NO. 57-1408
REPLACES 178-888

GRACO LIST PRICES ARE BASED ON SINGLE UNIT PRICE IN GRACO U.S. PRICE LIST DATED 1/4/11

To order, contact your local
Paint Spray Equipment Dealer and ask for
Genuine Bedford Replacement Parts.

BEDFORD® Replacement Parts For . . . GRACO Equipment

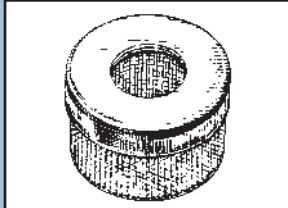

PART NO. 14-1224 REPLACES 181-073	1/2"
PART NO. 14-1428 REPLACES 183-770	3/4"
PART NO. 14-1223 REPLACES 181-072	1"
PART NO. 14-2179 REPLACES 189-920	1"

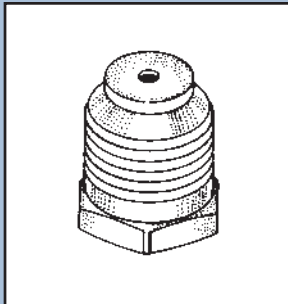

PART NO. 12-1486
REPLACES 181-085

REPLACES GRACO PART NO.	BEDFORD PART NO.	DESCRIPTION	GRACO LIST PRICE (\$)
160-028	0-422	O-Ring	—
160-158	10-686	Gasket	16.80
160-170	5-145	Gasket	—
160-240	7-569	Packing	2.55
160-258	0-1105	Packing	12.50
160-260	—	Order as: (1) pc 170-708 & (1) pc 160-896	—
160-261	44-838	Nut	—
160-325	0-254	O-Ring	13.20
160-430	28-759	Gauge, 1/4" NPT Btm Mount, 0-100 PSI, 2"	23.70
160-618	23-837	Wire	—
160-621	0-133	O-Ring	9.45
160-624	0-616	Packing	14.40
160-625	0-134	O-Ring	15.10
160-634	16-801	Packing	15.80
160-644	16-1605	Flat Packing	12.60
160-671	10-1606	Gasket, Copper	4.20
160-672	18-1607	Guide, Upper	29.40
160-673	16-1608	Packing, Upper	16.80
160-674	6-1609	Washer, Backup	11.60
160-675	18-1610	Guide, Lower	28.40
160-678	18-1611	Guide, Displacement Tube	12.60
160-679	16-1612	Packing	15.80
160-680	6-1613	Guide, Displacement Tube	20.00
160-681	8-1614	Nylon Seal	20.00
160-721	0-1054	O-Ring	12.60
160-896	44-835	Stem	—
161-077	12-411	Swivel Adapter 1/2" NPT(f) x 3/8" NPS(f)	14.90
161-355	—	Replaced by 171-912 (10-859)	—
161-387	0-423	O-Ring	—
161-397	0-421	O-Ring	—
161-416	0-141	O-Ring	—
161-547	0-961	O-Ring	33.60
161-553	10-688	Gasket	5.40
161-559	7-679	Washer	7.55
161-560	16-633	Packing	23.30
161-561	—	Replaced by 214-852 (47-1662)	—
161-562	11-433	V-Packing	28.10
161-563	7-234	Backup Leather	12.10
161-569	10-434	Seal	34.50
161-572	0-1039	O-Ring	6.10
161-575	23-1648	Spring	16.90
161-578	0-462	O-Ring	42.40
161-589	23-1649	Spring	24.20
161-635	10-687	Gasket	10.00
161-647	—	Replaced by 172-688 (8-977)	—
161-673	10-1267	Gasket	17.20
161-788	4-342	Piston Cup Seal	21.50
161-789	42-819	Bearing	39.20
161-793	4-343	Piston Cup Seal	22.20
161-794	42-820	Bearing	52.00

GRACO LIST PRICES ARE BASED ON SINGLE UNIT PRICE IN GRACO U.S. PRICE LIST DATED 1/4/11

BEDFORD® Replacement Parts For . . . GRACO Equipment

To order, contact your local
Paint Spray Equipment Dealer and ask for
Genuine Bedford Replacement Parts.

REPLACES GRACO PART NO.	BEDFORD PART NO.	DESCRIPTION	GRACO LIST PRICE (\$)
161-950	8-505	Nylon Packing	36.10
162-302	8-504	Nylon Packing	13.60
162-309	8-510	Nylon Packing	22.60
162-391	1-703	Leather V-Packing	6.30
162-453	12-219	Nipple 1/4" NPT x 1/4" NPS	14.10
162-505	12-406	Swivel Adapter 3/8" NPT(m) x 1/2" NPS(f)	14.00
162-636	3-235	Flange Packing	—
162-642	3-236	Leather Cup	24.40
162-694	1-670	Leather V-Packing	2.80
162-841	0-604	O-Ring	8.80
162-863	8-122	Nylon Tip Gasket 5/32" (Thick)	.80
162-865	4-109	Teflon Cup Packing	30.20
162-866	2-110	Teflon V-Packing	10.90
162-867	4-373	Teflon Flange Packing	48.70
162-868	4-372	Teflon Cup Packing	39.30
162-870	4-993	Packing	67.50
162-871	4-237	Teflon Cup Packing	46.40
162-898	10-981	Gasket	26.20
162-989	5-106	Gasket	3.25
163-010	7-108	Backup Washer	5.20
163-011	11-107	V-Packing	9.40
164-075	8-162	Base, Tip Filter	7.10
164-111	8-241	Gasket	6.05
164-112	23-702	Spring	7.05
164-116	7-120	Packing	2.55
164-120	12-620	Filter Retainer / Adapter, Stainless Steel	32.50
164-396	—	Replaced by 179-983 (18-1082)	—
164-397	1-111	Leather V-Packing	12.50
164-398	—	Replaced by 179-984 (18-1083)	—
164-477	1-115	Leather V-Packing	5.20
164-480	6-378	Teflon Gasket	11.20
164-481	—	Replaced by 178-902 (57-1405)	—
164-555	2-678	Teflon V-Packing	17.20
164-557	15-171	Teflon O-Ring	19.50
164-622	15-424	Teflon O-Ring	31.00
164-623	15-671	Teflon O-Ring	22.90
164-627	16-747	Seal	23.40
164-651	—	Replaced by 178-899 (57-1406)	—
164-652	6-388	Teflon Gasket	13.50
164-654	12-1479	Retainer	36.40
164-655	—	Replaced by 186-132 (18-2159)	—
164-656	1-117	Leather V-Packing	9.75
164-657	—	Replaced by 186-133 (18-1905)	—
164-659	—	Replaced by 178-900 (57-1407)	—
164-713	18-383	Packing Retainer	6.45
164-714	—	Replaced by 179-987 (18-1087)	—
164-715	1-112	Leather V-Packing	3.95
164-716	—	Replaced by 179-988 (18-1088)	—
164-778	42-148	Bearing	—
164-782	15-427	Teflon O-Ring	30.30

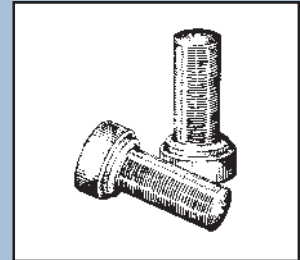

PART NO. 14-151 100M
REPLACES 205-264

PART NO. 14-152 60M
REPLACES 205-265

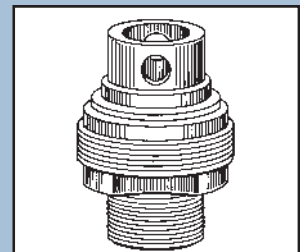

PART NO. 58-1583
REPLACES 205-981

PART NO. 58-1582
REPLACES 206-399

GRACO LIST PRICES ARE BASED ON SINGLE UNIT PRICE IN GRACO U.S. PRICE LIST DATED 1/4/11

To order, contact your local
Paint Spray Equipment Dealer and ask for
Genuine Bedford Replacement Parts.

BEDFORD® Replacement Parts For . . . GRACO Equipment

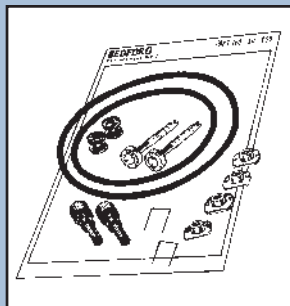

PART NO. 20-850
REPLACES 206-728

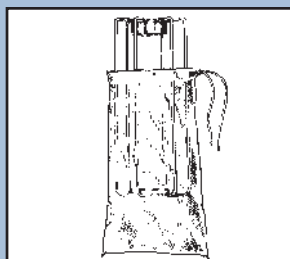

PART NO. 14-700 3/4"
REPLACES 208-241

PART NO. 14-900 1-1/4"
REPLACES 210-726

REPLACES GRACO PART NO.	BEDFORD PART NO.	DESCRIPTION	GRACO LIST PRICE (\$)
164-788	42-119	Bearing	—
164-837	18-609	Male Gland	18.00
164-846	15-460	Teflon O-Ring	34.30
164-862	2-116	Teflon V-Packing	11.10
164-891	15-172	Teflon O-Ring	29.80
164-900	8-242	Backup Washer	5.80
164-902	—	Replaced by 172-094 (8-896)	—
164-912	2-113	Teflon V-Packing	15.40
164-913	2-114	Teflon V-Packing	16.80
164-918	2-118	Teflon V-Packing	8.85
164-920	4-390	Teflon Cup Packing	99.75
164-964	15-238	Teflon O-Ring	26.10
165-052	15-239	Teflon O-Ring	21.30
165-098	2-167	Teflon V-Packing	21.90
165-102	2-677	Teflon V-Packing	22.40
165-104	2-165	Teflon V-Packing	19.50
165-109	2-591	Teflon V-Packing	18.70
165-274	12-1394	1/4" NPT(m) Stud	12.50
165-287	6-651	Bearing	18.00
165-288	18-650	Female Gland	37.00
165-289	—	Replaced by 166-133 (11-1750)	—
165-292	6-514	Piston Bearing	14.40
165-295	0-612	O-Ring	12.20
165-592	—	Replaced by 181-085 (12-1486)	—
165-599	12-1395	Stud, 3/8" NPT(m)	27.10
165-651	2-240	Teflon V-Packing	—
165-672	2-420	Teflon V-Packing	9.15
165-894	18-256	Male Gland	8.15
165-895	18-257	Female Gland	7.35
165-944	18-978	Male Gland	—
165-945	18-979	Female Gland	—
165-964	12-1396	Nut	26.40
166-026	6-511	Piston Seal	33.60
166-073	15-469	Teflon O-Ring	23.30
166-075	2-437	Teflon V-Packing	23.20
166-080	0-143	O-Ring	4.50
166-119	0-984	O-Ring	4.35
166-133	11-1750	Packing	7.30
166-165	2-147	Teflon V-Packing	16.20
166-226	2-180	Teflon V-Packing	24.30
166-228	18-991	Male Gland	14.50
166-229	18-980	Female Gland	29.50
166-238	0-841	O-Ring	6.45
166-258	7-1382	Packing	4.05
166-374	—	Replaced by 168-283 (6-613)	—
166-375	18-512	Female Gland	112.50
166-378	0-717	O-Ring	7.65
166-395	8-515	Nylon Packing	32.70
166-411	15-395	Teflon O-Ring	57.00
166-412	15-396	Teflon O-Ring	23.10

GRACO LIST PRICES ARE BASED ON SINGLE UNIT PRICE IN GRACO U.S. PRICE LIST DATED 1/4/11

BEDFORD® Replacement Parts For . . . GRACO Equipment

To order, contact your local
Paint Spray Equipment Dealer and ask for
Genuine Bedford Replacement Parts.

REPLACES GRACO PART NO.	BEDFORD PART NO.	DESCRIPTION	GRACO LIST PRICE (\$)
166-487	18-1619	Male Gland	55.25
166-488	18-1620	Female Gland	82.00
166-489	1-341	Leather V-Packing	14.90
166-490	1-1113	Packing	15.10
166-512	6-608	Washer	7.65
166-564	6-1100	Bearing	9.85
166-602	3-1076	Leather Cup	48.30
166-603	1-1077	Leather V-Packing	30.70
166-612	15-507	Teflon O-Ring	14.50
166-623	15-463	Teflon O-Ring	10.20
166-624	15-466	Teflon O-Ring	21.10
166-650	10-804	Gasket	—
166-651	10-805	Gasket	—
166-652	10-1621	Gasket	12.90
166-653	10-1622	Gasket	12.40
166-702	0-2244	O-Ring	4.15
166-769	2-994	Teflon V-Packing	9.05
166-770	2-849	Teflon V-Packing	28.00
166-811	6-414	Valve Seat	13.80
166-815	18-822	Male Gland	15.20
166-816	2-435	Teflon V-Packing	8.05
166-817	18-823	Female Gland	23.90
166-969	8-173	Nylon Tip Washer 1/16" (Thin)	.65
166-985	15-1103	Teflon O-Ring	19.90
166-987	4-1160	Packing	—
167-024	14-184	Strainer, Manifold Filter - 30 Mesh (Long)	8.95
167-025	14-185	Strainer, Manifold Filter - 60 Mesh (Long)	8.95
167-026	14-186	Strainer, Manifold Filter - 100 Mesh (Long)	8.95
167-027	14-187	Strainer, Manifold Filter - 200 Mesh (Long)	8.95
167-052	14-192	Strainer, Manifold Filter - 30 Mesh (Short)	8.95
167-053	14-193	Strainer, Manifold Filter - 60 Mesh (Short)	8.95
167-054	14-194	Strainer, Manifold Filter - 100 Mesh (Short)	8.95
167-055	14-195	Strainer, Manifold Filter - 200 Mesh (Short)	8.95
167-077	—	Replaced by 178-898 (57-1403)	—
167-354	18-997	Male Gland	64.25
167-355	18-998	Male Gland	82.00
167-585	23-1650	Spring	12.60
167-664	18-1365	Female Gland	27.70
167-665	2-848	Teflon V-Packing	15.20
167-666	1-1326	Leather V-Packing	10.50
167-667	18-1366	Male Gland	18.90
167-668	6-1350	Gasket	11.90
167-730	10-684	Gasket	3.45
167-893	—	Replaced by 178-894 (57-1409)	—
167-894	6-854	Gasket	5.10
167-896	—	Replaced by 186-130 (18-1656)	—
167-897	1-464	Leather V-Packing	8.85
167-898	2-468	Teflon V-Packing	10.60
167-899	—	Replaced by 186-131 (18-1902)	—
167-901	—	Replaced by 178-888 (57-1408)	—

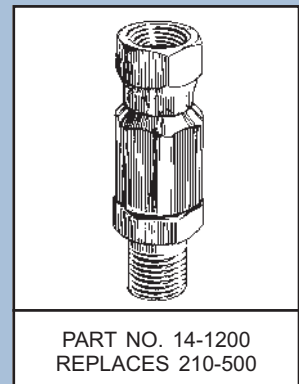
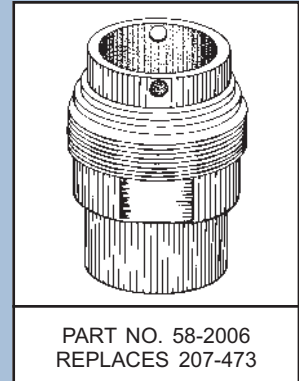

GRACO LIST PRICES ARE BASED ON SINGLE UNIT PRICE IN GRACO U.S. PRICE LIST DATED 1/4/11

To order, contact your local
Paint Spray Equipment Dealer and ask for
Genuine Bedford Replacement Parts.

BEDFORD® Replacement Parts For . . . GRACO Equipment

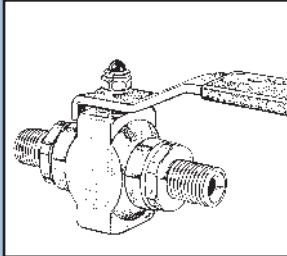

PART NO. 29-1440
REPLACES 210-657 1/4"

PART NO. 29-1441
REPLACES 210-658 3/8"

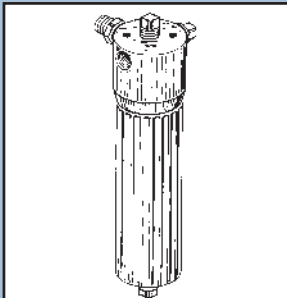

PART NO. 14-1566
REPLACES 214-570

REPLACES GRACO PART NO.	BEDFORD PART NO.	DESCRIPTION	GRACO LIST PRICE (\$)
167-969	8-1078	Bearing	105.50
167-971	16-1184	Piston Seal	46.20
167-972	0-985	O-Ring	1.45
168-110	0-1104	O-Ring	2.15
168-183	10-689	Gasket	8.00
168-283	6-613	Bearing	32.20
168-285	6-614	Bearing	22.80
168-506	16-1072	Packing	49.80
168-517	12-1201	Housing	32.90
168-521	10-1455	Copper Washer	—
168-548	2-216	Teflon V-Packing	—
168-851	18-1615	Male Gland	13.00
168-852	18-1616	Bearing	42.00
169-133	18-1042	Female Gland	40.70
169-429	2-340	Teflon V-Packing	—
169-605	18-538	Female Gland	12.50
169-606	18-537	Male Gland	12.90
169-607	1-590	Leather V-Packing	5.65
169-608	2-426	Teflon V-Packing	11.70
169-967	12-1332	Quick Disconnect Plug 1/4" NPT(f)	1.20
169-970	12-1333	Quick Disconnect Plug 1/4" NPT(m)	1.10
169-971	12-1334	Quick Disconnect Plug 3/8" NPT(m)	2.10
170-101	10-1265	Gasket	9.00
170-110	10-596	Washer	4.10
170-240	—	Use 4' x 3/4" Fluid Hose (13-1190)	—
170-607	—	Replaced by 206-345 (58-1584)	—
170-608	—	Replaced by 206-345 (58-1584)	—
170-625	49-737	Packing	15.20
170-626	49-802	Packing	58.50
170-706	13-2557	4' x 1" ID Suction Hose (Cut Length)	48.50
170-708	43-829	Poppet	10.20
170-709	43-828	Poppet	9.90
170-959	—	Replaced by 181-072 (14-1223)	—
171-146	18-667	Male Gland	6.75
171-163	18-1623	Gasket	15.50
171-590	17-861	Spreader	24.20
171-593	10-866	Washer	—
171-594	10-825	Washer	4.55
171-912	10-859	Gasket	3.25
171-913	10-860	Gasket	3.25
171-939	44-1305	Filter Support (Aluminum), Outlet Manifold	22.80
171-941	23-1563	Spring, Manifold Outlet Filter	6.95
171-942	12-1564	Head, Manifold Outlet Filter	104.50
172-094	8-896	Seat	10.40
172-383	—	Replaced by 178-543 (18-1467)	—
172-384	1-583	Leather V-Packing	8.40
172-385	18-1463	Male Gland	17.50
172-392	3-578	Leather Cup	8.90
172-423	18-857	Male Gland	11.30
172-424	18-858	Female Gland	13.00

GRACO LIST PRICES ARE BASED ON SINGLE UNIT PRICE IN GRACO U.S. PRICE LIST DATED 1/4/11

BEDFORD® Replacement Parts For . . . GRACO Equipment

To order, contact your local
Paint Spray Equipment Dealer and ask for
Genuine Bedford Replacement Parts.

REPLACES GRACO PART NO.	BEDFORD PART NO.	DESCRIPTION	GRACO LIST PRICE (\$)
172-487	2-577	Teflon V-Packing	9.10
172-489	4-1464	Teflon Cup	19.30
172-580	17-203	Spreader	21.50
172-688	8-977	Washer	40.30
172-831	44-1565	Bowl, Manifold Outlet Filter	105.00
172-846	1-940	Leather V-Packing	8.00
172-871	2-919	Teflon V-Packing	24.70
176-167	49-1115	Gasket	2.75
176-648	—	Replaced by 181-084 (12-1587)	—
176-747	18-1282	Female Gland	7.10
176-749	1-1240	Leather V-Packing	3.35
176-750	18-1283	Male Gland	3.15
176-751	19-2628	Lower Packing Nut - Ultra 400, 390st, 490st	10.40
176-754	18-1284	Male Gland	5.60
176-755	1-1241	Leather V-Packing	5.00
176-756	—	Replaced by 176-997 (49-1276)	—
176-757	18-1285	Female Gland	3.35
176-759	19-1286	Pin	14.20
176-761	10-1287	Gasket	3.90
176-818	44-2654	Attach Pin	6.50
176-882	49-1275	V-Packing	7.00
176-884	8-1288	Backup Washer	3.15
176-920	—	Replaced by 188-150 (13-499)	—
176-997	49-1276	V-Packing	7.25
177-159	49-1465	Cup Packing	19.50
177-164	49-1466	Packing	8.35
177-222	49-1523	Needle Packing	—
177-223	18-1524	Gland	—
177-929	57-1435	Cylinder - EM390, EM490, Ultra 400/500	278.50
178-543	18-1467	Female Gland	44.60
178-743	12-1397	Valve Housing	36.90
178-745	12-1398	Valve Stem	27.50
178-746	9-1257	Valve Ball	24.80
178-747	20-1446	Heavy Duty Lever Kit - Ball Valve	9.45
178-888	57-1408	Rod - 45:1 King, GH733, 20:1 Bulldog (SD)	745.00
178-894	57-1409	Sleeve - 45:1 King, GH733, 20:1 Bulldog (SD)	788.00
178-898	57-1403	Sleeve - 23:1 Monark, EH333 (SD)	544.00
178-899	57-1406	Rod - 30:1 Bulldog, GH533, 63:1 King (SD)	721.00
178-900	57-1407	Sleeve - 30:1 Bull, GH533, 63:1 King (SD)	784.00
178-902	57-1405	Sleeve - 30:1 Pres, EH433GT, GH433 (SD)	586.00
178-938	19-1289	Pin	7.60
178-939	1-1242	Leather V-Packing	—
178-940	1-1243	Leather V-Packing	6.80
178-942	18-1294	Male Gland	7.60
178-943	18-1295	Female Gland	11.40
178-944	18-1296	Male Gland	7.35
178-945	19-2629	Lower Packing Nut - GM3500, Ultra 1000	12.60
178-949	57-1439	Cylinder - Ultra 333/433/750/1000, GM3500	294.00
178-964	49-1297	V-Packing	5.10
178-965	49-1298	V-Packing	6.35

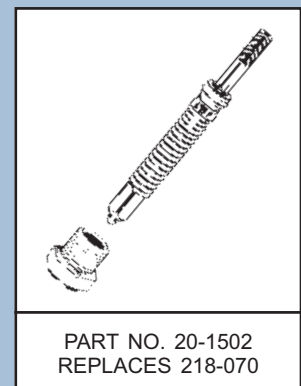
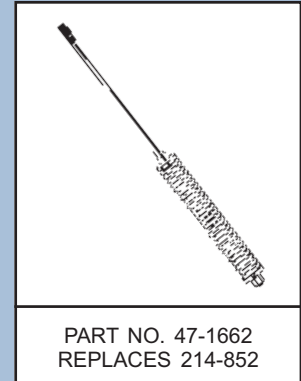

GRACO LIST PRICES ARE BASED ON SINGLE UNIT PRICE IN GRACO U.S. PRICE LIST DATED 1/4/11

To order, contact your local
Paint Spray Equipment Dealer and ask for
Genuine Bedford Replacement Parts.

BEDFORD® Replacement Parts For . . . GRACO Equipment



PART NO. 14-1484 50M
REPLACES 218-131

PART NO. 14-1485 100M
REPLACES 218-133

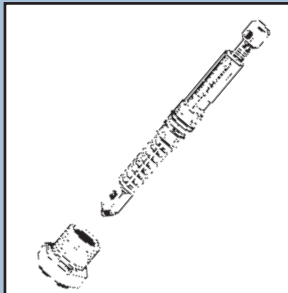

PART NO. 20-1401
REPLACES 218-143

REPLACES GRACO PART NO.	BEDFORD PART NO.	DESCRIPTION	GRACO LIST PRICE (\$)
178-969	18-1299	Female Gland	10.80
179-722	8-1476	Retainer	2.90
179-731	14-1118	Gun Filter Element - 50 Mesh, Coarse	3.60
179-732	14-1120	Gun Filter Element - 100 Mesh, Fine	3.55
179-750	8-1475	Retainer	3.25
179-762	10-1525	Washer, Backup	—
179-763	23-1478	Spring	3.25
179-810	17-2422	Plug	2.90
179-957	8-1477	Retainer	2.90
179-983	18-1082	Gland	4.40
179-984	18-1083	Male Gland	8.50
179-987	18-1087	Gland	8.50
179-988	18-1088	Gland	3.70
180-073	18-1290	Female Gland	7.60
180-161	—	Replaced by 186-652 (18-1846)	—
180-656	17-2424	Plug	2.75
181-072	14-1223	Inlet Strainer - 1" NPT (Stainless Steel Cap)	15.50
181-073	14-1224	Inlet Strainer - 1/2" NPT (Stainless Steel Cap)	17.80
181-084	12-1587	Gun Adapter - Binks Gun to RAC Tip	13.00
181-085	12-1486	Gun Adapter - RAC, Pole Gun, Wagner Gun	8.35
181-338	18-1301	Backup Washer	2.90
181-072P	14-2353	Inlet Strainer - 1" NPT (Nylon Cap)	—
181-073P	14-2351	Inlet Strainer - 1/2" NPT (Nylon Cap)	—
181-879	57-1360	Rod - Ultra 400/500, EM380/390/490	135.00
183-171	17-1542	Plug	2.90
183-172	6-1539	Teflon Packing	17.30
183-173	19-1544	Pin, Ball Stop	5.70
183-174	1-1545	Leather V-Packing	5.50
183-175	1-1546	Leather V-Packing	5.50
183-176	18-1547	Male Gland	10.30
183-177	18-1548	Female Gland	13.50
183-178	18-1549	Male Gland	13.50
183-181	57-2383	Cylinder - GM5000, GM10000, Ultra 1500	253.50
183-182	49-1550	V-Packing	3.15
183-183	49-1551	V-Packing	3.60
183-184	—	Replaced by 186-653 (18-1904)	—
183-185	18-1553	Female Gland	14.60
183-239	—	Replaced by 183-563 (57-1748)	—
183-361	57-1599	Sleeve - GM5000, Ultra 1500, GM 10000	294.00
183-548	58-1979	Seat - Thumb Screw Dump Valve	16.30
183-555	19-1516	Pin	15.70
183-563	57-1748	Rod - Ultra 400/500, EM380/390/490	222.00
183-571	57-1749	Sleeve - Ultra 400/500, EM380/390/490	149.50
183-640	18-1371	Male Gland	20.30
183-641	18-1372	Female Gland	23.40
183-642	18-1373	Male Gland	22.80
183-643	18-1374	Female Gland	22.80
183-644	18-1375	Male Gland	24.80
183-645	18-1376	Female Gland	17.00
183-770	14-1428	Inlet Strainer - 3/4" NPT (Stainless Steel Cap)	17.80

GRACO LIST PRICES ARE BASED ON SINGLE UNIT PRICE IN GRACO U.S. PRICE LIST DATED 1/4/11

BEDFORD® Replacement Parts For . . . GRACO Equipment

To order, contact your local
Paint Spray Equipment Dealer and ask for
Genuine Bedford Replacement Parts.

REPLACES GRACO PART NO.	BEDFORD PART NO.	DESCRIPTION	GRACO LIST PRICE (\$)
183-978	2-1899	Teflon V-Packing	11.40
183-770P	14-2352	Inlet Strainer - 3/4" NPT (Nylon Cap)	—
184-198	18-2292	Female Gland	10.40
184-248	18-2293	Male Gland	10.40
184-303	1-2290	Leather V-Packing	13.90
185-211	57-2423	Cylinder - GM3500, Ultra 1000	220.00
185-213	57-1911	Sleeve - Ultra 750/1000, GM3500	192.00
185-385	10-1903	Shim	2.80
186-130	18-1656	Male Gland	19.40
186-131	18-1902	Female Gland	20.40
186-132	18-2159	Male Gland	14.30
186-133	18-1905	Female Gland	14.30
186-181	18-1896	Female Gland	9.85
186-182	18-1897	Male Gland	9.85
186-194	18-1914	Female Gland	6.45
186-196	18-1916	Male Gland	13.40
186-198	18-1917	Female Gland	6.45
186-199	18-1918	Backup Washer	9.30
186-652	18-1846	Backup Washer	4.05
186-653	18-1904	Backup Washer	8.85
187-060	8-1980	Gasket	2.05
187-147	—	Replaced by 181-072 (14-1223)	—
187-190	—	Replaced by 183-770 (14-1428)	—
187-613	57-1948	Rod - 390st	96.00
187-615	—	Replaced by 15E-022 (58-2317)	—
187-621	12-2318	Housing, Drain Valve	—
187-623	23-2320	Spring	—
187-634	—	Replaced by 236-786 (57-2131)	—
188-150	13-499	Suction Hose, 3/4" x 3' (No Fittings)	24.40
189-584	18-2253	Female Gland	8.45
189-585	18-2254	Male Gland	14.00
189-587	10-2255	Backup Washer	17.70
189-588	18-2256	Female Gland	14.80
189-590	6-2257	Gasket	5.05
189-920	14-2179	Inlet Strainer - 1" NPT, 8 Mesh, Single Screen	20.30
190-180	17-1437	Lever, Ball Valve	30.40
192-642	20-2717	Intake Valve Kit - Seat (15/16"), Ball & O-Ring	75.75
192-692	49-2285	Polyethylene V-Packing	5.45
192-693	49-2286	Polyethylene V-Packing	4.50
192-710	49-2279	Polyethylene V-Packing	5.45
192-712	49-2280	Polyethylene V-Packing	4.50
192-714	23-2287	Throat Spacer	4.95
192-729	—	Replaced by 195-368 (23-2402)	—
192-848	18-2288	Male Gland	—
193-069	18-2282	Male Gland	3.35
193-124	49-2335	Polyethylene V-Packing	3.35
193-125	49-2336	Polyethylene V-Packing	2.95
193-127	23-2337	Throat Spacer	3.75
193-397	23-2376	Spacer	5.30
193-722	49-2377	Polyethylene V-Packing	2.20

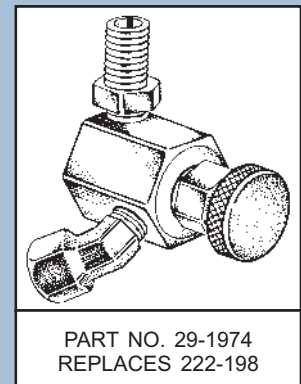
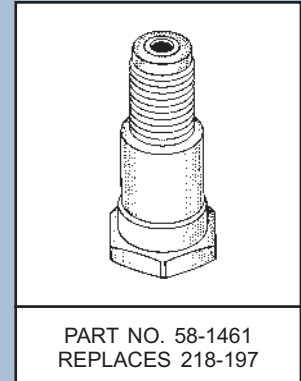

GRACO LIST PRICES ARE BASED ON SINGLE UNIT PRICE IN GRACO U.S. PRICE LIST DATED 1/4/11

To order, contact your local
Paint Spray Equipment Dealer and ask for
Genuine Bedford Replacement Parts.

BEDFORD® Replacement Parts For . . . GRACO Equipment

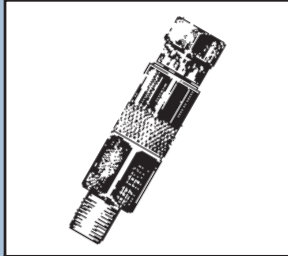

PART NO. 12-1900
REPLACES 223-341

PART NO. 12-2400
REPLACES 239-663



PART NO. 57-1402
REPLACES 223-603

REPLACES GRACO PART NO.	BEDFORD PART NO.	DESCRIPTION	GRACO LIST PRICE (\$)
194-117	44-2373	Pin	30.50
194-175	18-2372	Female Gland	8.50
195-083	—	Replaced by 243-070	—
195-129	18-2398	Male Gland	4.35
195-134	10-2549	Spacer	1.90
195-136	15-2401	Teflon O-Ring	1.60
195-368	23-2402	Spacer	—
195-488	8-2378	Piston Guide	21.90
195-523	44-2374	Pin	18.30
196-757	—	Replaced by (1) each: 118-504 & 15C-997	—
196-758	—	Replaced by (1) each: 118-503 & 15C-997	—
196-759	—	Replaced by 15G-234 (52-2743)	—
196-866	58-2712	Intake Seat (1-1/4") - UMax1595, GMax5900	82.75
196-880	18-2426	Male Gland	2.60
197-443	44-2634	Pin	8.15
198-303	42-2574	Guide	19.50
198-701	49-2635	Polyethylene V-Packing	3.75
198-718	1-2636	Leather V-Packing	9.30
198-765	18-2637	Female Gland	12.00
198-768	18-2638	Male Gland	12.00
198-967	18-2573	Male Gland	—
204-164	20-1617	Kit - 45:1 Fireball	237.00
204-940	—	Replaced by 239-663 (12-2400)	—
205-139	—	Replaced by 210-867 (13-354)	—
205-142	13-481	25' x 3/8" Fluid Hose Assembly	83.00
205-143	13-482	50' x 3/8" Fluid Hose Assembly	—
205-160	13-485	15' x 3/8" Fluid Hose Assembly	72.25
205-264	14-151	Tip Filter, 100 Mesh, Fine, Enamel & Stain	7.40
205-265	14-152	Tip Filter, 60 Mesh, Coarse, Latex	7.40
205-516	58-1768	Piston Valve - 30:1 Bull, GH533, 63:1 King	245.00
205-538	58-1581	Piston Valve - EH333, 23:1 Monark	95.75
205-981	58-1583	Intake Valve - EH433GT, GH433, 30:1 Pres	393.00
205-982	—	Available Only as 205-981 Intake Valve	—
206-199	—	Order as (1) each: 26-714 & 28-719	—
206-345	58-1584	Piston Valve - EH433GT, GH433, 30:1 Pres	56.75
206-399	58-1582	Intake Valve - EH333, 23:1 Monark	444.00
206-728	20-850	Kit - Fireball & Monark Air Motor	88.75
206-729	—	Replaced by 218-135 (20-1084)	—
206-733	20-380	Kit - 30:1 President, Viscount 3000	112.00
206-734	20-631	Kit - Bulldog Air Motor (7")	109.50
206-735	20-381	Kit - 30:1 Bulldog, GH533, 63:1 King	174.50
206-761	20-1626	Kit - 3:1 President	242.00
206-922	20-1050	Kit - 2:1 Monark	205.00
206-923	20-751	Kit - 5:1 Monark, 10:1 Pres, Viscount 1000	129.00
206-924	20-1047	Kit - 5:1 Fireball	177.00
206-926	20-1074	Kit - 5:1 Monark, 10:1 President	237.00
206-927	20-386	Kit - 9:1 & 10:1 President	187.00
206-933	20-315	Kit - 10:1 Bulldog Double Ball	—
206-934	20-806	Kit - 10:1 Bulldog HydraClean	276.00
206-935	—	Order as: (3) pc 207-839 (20-634)	—

GRACO LIST PRICES ARE BASED ON SINGLE UNIT PRICE IN GRACO U.S. PRICE LIST DATED 1/4/11

BEDFORD® Replacement Parts For . . . GRACO Equipment

To order, contact your local
Paint Spray Equipment Dealer and ask for
Genuine Bedford Replacement Parts.

REPLACES GRACO PART NO.	BEDFORD PART NO.	DESCRIPTION	GRACO LIST PRICE (\$)
206-939	20-384	Kit - Reverse-A-Clean (RAC)	—
207-084	—	Replaced by 223-603 (57-1402)	—
207-182	20-385	Kit - 1:1 Pump	76.50
207-240	14-370	Filter Bags - 12 Pack	55.80
207-241	14-700	Filter Assembly - For 3/4" Tube	49.30
207-308	20-990	Kit - HydraClean Valve	61.00
207-385	20-845	Kit - President Air Motor	81.75
207-386	20-1351	Kit - 15:1 President	134.00
207-472	58-1769	Piston Valve - 45:1 King, GH733, 20:1 Bull	234.00
207-473	58-2006	Intake Valve - 45:1 King, GH733, 20:1 Bull	515.00
207-580	20-606	Kit - 5:1 Monark, 10:1 President	179.00
207-581	20-999	Kit - 10:1 Bulldog (SS, Teflon)	339.00
207-729	20-983	Kit - 20:1 King, 10:1 Bulldog, GH833	295.00
207-730	20-632	Kit - King Air Motor (10")	109.00
207-839	20-634	Kit - High Pressure Swivel (Leather)	22.60
207-846	20-387	Kit - 1:1 Solvent Fast-Flo	88.75
207-847	20-371	Kit - 1:1 Fast-Flo SS	—
207-849	—	Replaced by 218-136 (20-1114)	—
207-850	20-681	Kit - 28:1 & 30:1 President (Teflon)	113.00
207-851	20-643	Kit - 30:1 Bull, GH533, 63:1 King (Teflon)	168.00
207-884	20-1178	Kit - 5:1 Monark (Teflon)	149.00
207-917	20-1085	Kit - 5:1 Monark	133.00
207-949	20-1081	Kit - 10:1 President (Viton, SS)	149.00
207-966	20-855	Kit - 20:1 Bulldog, 45:1 King, GH733	156.00
208-178	20-821	Kit - 2:1 Standard Pump	146.00
208-238	20-840	Kit - SST Spray Guns	66.25
208-519	20-774	Kit - 5:1 Monark	146.00
208-520	20-607	Kit - 5:1 Monark Divorced	172.50
208-536	12-1330	Quick Disconnect Coupler 1/4" NPT(f)	8.65
208-919	20-389	Kit - EH433GT	89.25
208-940	20-379	Kit - EM400, EM480	89.25
210-041	—	Replaced by 223-589 (57-1404)	—
210-500	14-1200	Inline Filter Assy, 1/4" NPT(m) x 1/4" NPS(f)	72.75
210-501	12-1202	Housing	65.50
210-539	20-1268	Kit - 55:1 King, 20:1 Bulldog	181.00
210-540	—	Replaced by 223-540 (13-931)	—
210-541	—	Replaced by 223-541 (13-932)	—
210-657	29-1440	1/4" NPT x 1/4" NPT 5000 PSI Ball Valve	72.25
210-658	29-1441	3/8" NPT x 3/8" NPT 5000 PSI Ball Valve	72.25
210-659	29-1442	3/8" NPT x 1/4" NPT 5000 PSI Ball Valve	72.25
210-726	14-900	Filter Assembly - For 1-1/4" Tube	43.50
210-826	—	Replaced by 217-559 (20-1259)	—
210-866	13-366	15' x 5/16" Air Hose Assembly (Smooth)	42.10
210-867	13-354	25' x 5/16" Air Hose Assembly (Smooth)	61.00
210-868	13-355	50' x 5/16" Air Hose Assembly (Smooth)	109.50
212-058	—	Order (1) ea: 164-120, 205-264/5, 162-863	—
212-079	20-1269	Kit - 40:1 Bulldog, Polyurethane	246.50
213-012	20-1468	Kit - 1:1 Metric Fast-Flo (Leather)	102.50
213-013	20-1469	Kit - 1:1 Metric Fast-Flo (Teflon)	102.50
214-037	29-1443	1/4" NPT(mbe) Teflon 5000 PSI Ball Valve	72.25

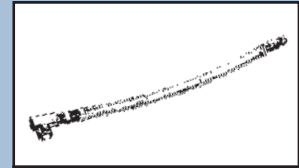

PART NO. 13-314 1/4"x15"
REPLACES 223-763 90°

PART NO. 13-1303 1/4"x23"
REPLACES 216-126 90°

PART NO. 13-1855 1/4" x
REPLACES 223-766 29"

PART NO. 13-2151 3/8" x
REPLACES 220-849 29"

PART NO. 13-2632 1/4" x
REPLACES 241-926 9-1/2"

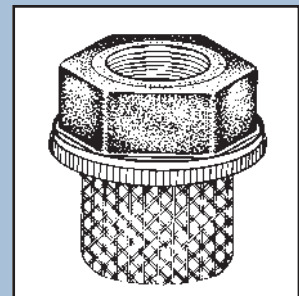

PART NO. 14-1964
REPLACES 235-004

GRACO LIST PRICES ARE BASED ON SINGLE UNIT PRICE IN GRACO U.S. PRICE LIST DATED 1/4/11

To order, contact your local
Paint Spray Equipment Dealer and ask for
Genuine Bedford Replacement Parts.

BEDFORD® Replacement Parts For . . . GRACO Equipment

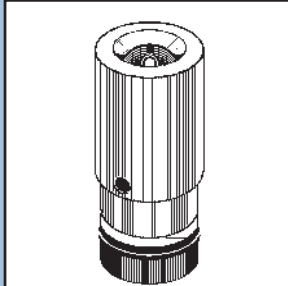

PART NO. 47-2370
REPLACES 235-009

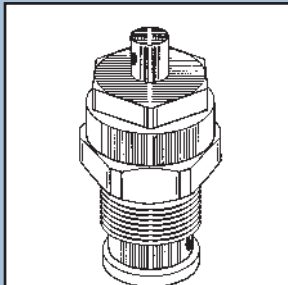

PART NO. 20-2324
REPLACES 235-014

REPLACES GRACO PART NO.	BEDFORD PART NO.	DESCRIPTION	GRACO LIST PRICE (\$)
214-570	14-1566	3000 PSI Fluid Outlet Filter Assembly	188.50
214-638	—	Replaced by 223-763 (13-314)	—
214-697	13-797	50' x 3/16" Airless Hose Assembly	72.50
214-698	13-796	25' x 3/16" Airless Hose Assembly	46.20
214-699	13-793	6' x 3/16" Airless Hose Assembly	39.20
214-700	13-791	2' x 3/16" Airless Hose Assembly	—
214-701	13-792	3' x 3/16" Airless Hose Assembly	—
214-703	13-451	25' x 3/8" Airless Hose Assembly	—
214-705	13-453	50' x 3/8" Airless Hose Assembly	—
214-730	20-1174	Kit - 2:1 Standard Pump	—
214-852	47-1662	Trip Rod Assy - Bulldog & King Air Motor	192.50
214-960	13-491	3-1/2' x 3/4" Suction Hose Assembly	74.50
214-961	13-492	6' x 3/4" Suction Hose Assembly	83.00
214-967	58-1430	Diffuser Seat Assembly - Silver/Flex Gun	—
214-981	13-795	15' x 3/16" Airless Hose Assembly	39.70
215-455	58-1585	Intake Valve - Ultra 400, EM380/390/490	345.00
215-496	20-1181	Kit - 45:1 King, GH733, 20:1 Bull (Teflon)	—
215-964	20-1470	Kit - 1:1 Metric Fast-Flo (Polyethylene)	93.50
216-126	13-1303	Outlet Return Hose Assy, 23" - EM480	—
217-474	—	Replaced by 207-851 (20-643)	—
217-475	—	Replaced by 206-735 (20-381)	—
217-476	58-2009	Intake Valve - 30:1 Bull, GH533, 63:1 King	534.00
217-541	—	Replaced by 223-589 (57-1404)	—
217-559	20-1259	Kit - Ball Valve, Viton Packed	66.75
217-560	20-1260	Kit - Ball Valve, Teflon Packed	66.75
217-574	58-1772	Intake Valve - Ultra 333/433/750/1000	249.50
218-017	—	Replaced by 222-438 (57-1910)	—
218-021	47-2062	Gun Swivel - Contractor Gun	69.00
218-023	58-1506	Diffuser Assembly - Contractor Gun	—
218-024	—	Replaced by Graco 238-169 (47-2261)	—
218-036	58-1775	Piston Valve - Ultra 333/433/1000, GM3500	97.50
218-070	20-1502	Kit - Contractor Gun	90.50
218-083	—	Replaced by 223-766 (13-1855)	—
218-122	20-1230	Kit - Senator Air Motor	91.00
218-129	58-1400	Needle Assembly - Silver/Flex Gun	—
218-131	14-1484	Gun Filter Assembly - 50 Mesh, Coarse	7.60
218-133	14-1485	Gun Filter Assembly - 100 Mesh, Fine	7.60
218-135	20-1084	Kit - 23:1 Monark, EH333, EH300	102.50
218-136	20-1114	Kit - 23:1 Monark, EH333 (Teflon)	88.50
218-143	20-1401	Kit - Silver Gun, Flex Gun	95.25
218-197	58-1461	Piston Valve - Ultra 400/600, EM380/390/490	60.50
218-559	20-1385	Kit - 15:1 President (Teflon)	66.50
218-578	—	Replaced by 218-083 (13-1304)	—
218-600	—	Order: (5) pcs 166-969 (8-173)	—
218-605	—	Replaced by 205-264 (14-151)	—
218-946	20-1488	Gun Adapter Kit	18.20
218-947	—	Order as: (1) pc 181-879 & (1) pc 218-197	—
218-948	—	Replaced by 222-587 (20-1526)	—
220-286	—	Replaced by 222-198 (29-1974)	—
220-366	—	Replaced by 222-588 (20-1499)	—

GRACO LIST PRICES ARE BASED ON SINGLE UNIT PRICE IN GRACO U.S. PRICE LIST DATED 1/4/11

BEDFORD® Replacement Parts For . . . GRACO Equipment

To order, contact your local
Paint Spray Equipment Dealer and ask for
Genuine Bedford Replacement Parts.

REPLACES GRACO PART NO.	BEDFORD PART NO.	DESCRIPTION	GRACO LIST PRICE (\$)
220-395	20-1355	Kit - 45:1 King, GH733, 20:1 Bulldog	177.50
220-396	20-1387	Kit - 15:1 President (SD)	114.50
220-397	—	Replaced by 223-675 (20-1898)	—
220-398	—	Replaced by 223-674 (20-1920)	—
220-399	20-1328	Kit - 30:1 Bulldog, GH533, 63:1 King	169.00
220-419	12-1314	Stop Bolt	—
220-629	58-1944	Intake Valve - GM5000/10000, Ultra 1500	292.50
220-630	57-1776	Rod - GM5000/10000, Ultra 1500	350.00
220-631	58-1938	Piston Valve - GM5000/10000, Ultra 1500	103.50
220-849	13-2151	Return Hose, 29"x3/8" - GM5000, Ultra 1500	69.50
220-877	20-1500	Kit - GM5000, Ultra 1500, GM10000	130.50
221-077	—	Order as: (1) pc 222-198 (29-1974)	—
221-098	58-2012	Intake Valve - Ultra 400, EM380/390/490	248.00
222-096	—	Replaced by 223-766 (13-1855)	—
222-198	29-1974	Drain Valve (Thumb Screw Type)	89.50
222-437	58-2014	Intake Valve - GM3500, EM590	264.00
222-438	57-1910	Rod - GM3500, Ultra 1000, EM590	270.00
222-587	20-1526	Kit - Ultra 400/500, EM380/390/490	59.50
222-588	20-1499	Kit - Ultra 333/433/1000, GM3500, EM590	72.00
223-341	12-1900	High Pressure Swivel, Teflon Packed	48.00
223-342	20-1935	Kit - Teflon Packed Swivel	49.00
223-365	20-1726	Packing Set - 45:1 King, GH733, 13:1 Sen	88.50
223-367	20-1727	Packing Set - 30:1 Bull, 63:1 King, GH533	85.00
223-371	—	Order as: (10) pcs 166-969 (8-173)	—
223-373	55-2451	Nylon Tip Washers (25), 1/16", Thin	10.00
223-374	55-2452	Nylon Tip Washers (25), 5/32", Thick	10.00
223-540	13-931	25' x 1/4" Airless Hose Assembly	—
223-541	13-932	50' x 1/4" Airless Hose Assembly	—
223-565	58-2306	Piston Valve (SS) - 30:1 President, GH433	157.00
223-589	57-1404	Rod - 30:1 Pres, EH433GT, GH433 (SD)	388.00
223-591	58-2307	Piston Valve (SS) - EH333, 23:1 Monark	121.00
223-603	57-1402	Rod - 23:1 Monark, EH333 (SD)	287.00
223-604	—	Order as: 178-899 (57-1408)	—
223-664	20-2434	Kit - EH433	88.75
223-674	20-1920	Kit - 23:1 Monark, EH333, EH300 (SD)	86.00
223-675	20-1898	Kit - 30:1 President, EH433GT, GH433 (SD)	121.00
223-763	13-314	Outlet Return Hose Assy, 15" - EM400	—
223-766	13-1855	Hose Assy, 29" - EM490, Ultra 400/333	—
223-959	29-1791	3/8" NPT x 1/4" NPT Ball Valve (Teflon)	87.50
223-960	29-1504	3/8" NPT x 3/8" NPT Ball Valve (Teflon)	87.50
224-449	—	Order as: (1) pc 210-657 (29-1440)	—
224-453	55-2454	Tip Filters (5), 100 Mesh, Fine, Enamel	39.00
224-454	55-2457	Tip Filters (5), 60 Mesh, Coarse, Latex	39.00
224-455	55-2483	Filter Elements (2), 50M, Contractor Gun	8.35
224-456	55-2484	Filter Elements (2), 100M, Contractor Gun	8.35
224-457	12-2485	1/4" Live Swivel, 3600 PSI, Leather Packed	43.90
224-458	55-2459	Strainers (2), Manifold Filter, 30 Mesh, Long	21.30
224-459	55-2462	Strainers (2), Manifold Filter, 60 Mesh, Long	21.30
224-468	55-2465	Strainers (2), Manifold Filter, 100 Mesh, Long	21.30
224-469	55-2468	Strainers (2), Manifold Filter, 200 Mesh, Long	21.30

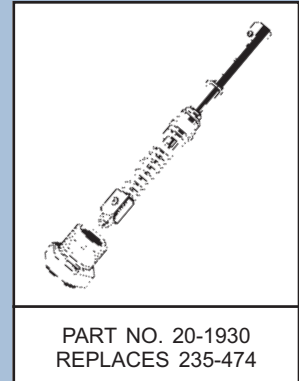

PART NO. 20-1930
REPLACES 235-474

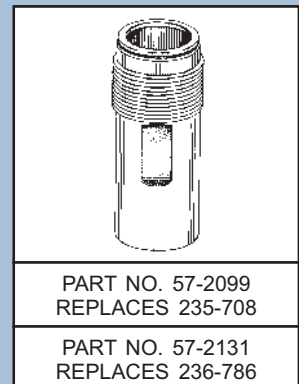

PART NO. 57-2099
REPLACES 235-708

PART NO. 57-2131
REPLACES 236-786

GRACO LIST PRICES ARE BASED ON SINGLE UNIT PRICE IN GRACO U.S. PRICE LIST DATED 1/4/11

To order, contact your local
Paint Spray Equipment Dealer and ask for
Genuine Bedford Replacement Parts.

BEDFORD® Replacement Parts For . . . GRACO Equipment



PART NO. 57-2672
REPLACES 240-517

PART NO. 57-2670
REPLACES 240-518

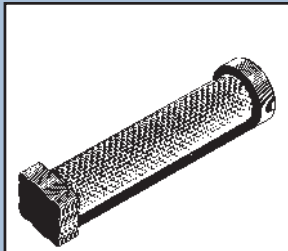

PART NO. 14-2650
REPLACES 243-070

REPLACES GRACO PART NO.	BEDFORD PART NO.	DESCRIPTION	GRACO LIST PRICE (\$)
224-771	20-2857	Seat Kit - PT2500, Pro201, FF-1000	31.50
224-775	29-2630	Drain Valve Housing & Stem Assembly	86.50
224-808	58-2212	Piston Valve - 290 Easy, 390st, 390sts	47.30
224-966	58-2215	Intake Valve - 390st, 490st, Ultra 600	85.25
224-968	58-2323	Stem Assembly - Dump Valve	—
224-998	—	Replaced by 235-703 (20-1856)	—
235-004	14-1964	Inlet Filter - 390st	13.10
235-009	47-2370	Kit - Pressure Transducer Assembly	131.00
235-014	20-2324	Kit - Bleed Valve	89.50
235-198	20-2078	Kit - Drain Valve	39.00
235-474	20-1930	Kit - Silver/Flex Gun Plus	93.75
235-557	—	Replaced by 218-197 (58-1461)	—
235-634	20-2932	Kit - 15:1 President	112.50
235-635	20-2079	Kit - 30:1 President, GH433	125.50
235-636	20-2310	Kit - 23:1 Monark, EH333 (Leather/Teflon/SS)	95.00
235-703	20-1856	Kit - 390st, 395st, 490st, 495st, Ultra 600	53.75
235-708	57-2099	Cylinder - 395/490/495st, GM3000, Ultra 600	143.50
235-709	57-1946	Rod - 395st, 490st, 495st, Ultra 600	108.50
236-079	47-2631	Poppet Valve Assembly	—
236-495	55-2471	Outlet Filter (2-pack), 30 Mesh, Short	21.30
236-496	55-2474	Outlet Filters (2-pack), 60 Mesh, Short	21.30
236-497	55-2477	Outlet Filters (2-pack), 100 Mesh, Short	21.30
236-498	55-2480	Outlet Filters (2-pack), 200 Mesh, Short	21.30
236-564	20-2258	Kit - GM7000	134.50
236-565	58-2562	Piston Valve - GM7000	103.50
236-566	57-2381	Sleeve - GM7000	299.00
236-567	57-2440	Rod - GM7000	376.00
236-724	20-2311	Kit - 23:1 Monark, EH333 (Teflon/SS)	114.00
236-786	57-2131	Cylinder - 390st, 390sts	136.50
237-239	20-2294	Kit - DuraFlo 750, 33:1 Bull (Leather/Teflon)	176.50
237-241	20-2314	Kit - DuraFlo 750, 33:1 Bulldog (Teflon)	183.00
237-522	13-2556	6' x 1" ID Suction Hose Assy	119.00
237-677	—	Order: Repair Kit 235-014 (20-2324)	—
237-725	20-2799	Kit - 30:1 President (Teflon, SS)	120.00
238-169	47-2261	Ball Holder Assembly - Contractor Gun	18.90
238-286	20-2690	Kit - 5:1 Fireball	105.00
238-358	—	Order: Hose Assy 214-701 (13-792)	—
238-359	—	Order: Hose Assy 214-699 (13-793)	—
238-435	55-2460	Outlet Filters (3-pack), 30 Mesh, Long	26.85
238-436	55-2461	Outlet Filters (25-pack), 30 Mesh, Long	223.75
238-437	55-2463	Outlet Filters (3-pack), 60 Mesh, Long	26.85
238-438	55-2464	Outlet Filters (25-pack), 60 Mesh, Long	223.75
238-439	55-2466	Outlet Filters (3-pack), 100 Mesh, Long	26.85
238-440	55-2467	Outlet Filters (25-pack), 100 Mesh, Long	223.75
238-441	55-2469	Outlet Filters (3-pack), 200 Mesh, Long	26.85
238-442	55-2470	Outlet Filters (25-pack), 200 Mesh, Long	235.00
238-443	55-2472	Outlet Filters (3-pack), 30 Mesh, Short	26.85
238-444	55-2473	Outlet Filters (25-pack), 30 Mesh, Short	223.75
238-445	55-2475	Outlet Filters (3-pack), 60 Mesh, Short	26.85
238-446	55-2476	Outlet Filters (25-pack), 60 Mesh, Short	223.75

GRACO LIST PRICES ARE BASED ON SINGLE UNIT PRICE IN GRACO U.S. PRICE LIST DATED 1/4/11

BEDFORD® Replacement Parts For . . . GRACO Equipment

To order, contact your local
Paint Spray Equipment Dealer and ask for
Genuine Bedford Replacement Parts.

REPLACES GRACO PART NO.	BEDFORD PART NO.	DESCRIPTION	GRACO LIST PRICE (\$)
238-447	55-2478	Outlet Filters (3-pack), 100 Mesh, Short	26.85
238-448	55-2479	Outlet Filters (25-pack), 100 Mesh, Short	223.75
238-449	55-2481	Outlet Filters (3-pack), 200 Mesh, Short	26.85
238-450	55-2482	Outlet Filters (25-pack), 200 Mesh, Short	223.75
238-561	55-2453	Tip Filters (3-pack), 100 Mesh, Fine, Enamel	28.60
238-562	55-2455	Tip Filters (25-pack), 100 Mesh, Fine, Enamel	185.00
238-563	55-2456	Tip Filters (3-pack), 60 Mesh, Coarse, Latex	28.60
238-564	55-2458	Tip Filters (25-pack), 60 Mesh, Coarse, Latex	185.00
238-612	—	Order as: (1) 210-658 (29-1441) Ball Valve	—
238-635	—	Order as: (1) 210-657 (29-1440) Ball Valve	—
238-692	—	Replaced by 235-703 (20-1856)	—
238-769	14-2170	Filter Bags (25-pack)	116.25
239-663	12-2400	1/4" Live Swivel, 3600 PSI, Leather Packed	48.00
239-914	20-2806	Kit - Bleed Valve	91.50
239-922	20-2673	Intake Seat Kit - Seat (15/16"), Ball & O-Ring	75.75
239-928	—	Replaced by 248-212 (20-2662)	—
239-932	58-2564	Piston Valve - GMax 3900, UltraMax 795/1095	122.50
239-939	—	Replaced by 244-194 (20-2428)	—
240-150	58-2567	Piston Valve - GMax 5900/10000, Mark IV	103.50
240-248	—	Replaced by 248-213 (20-2663)	—
240-516	—	Replaced by 243-177 (57-2831)	—
240-517	57-2672	Rod - UMax 1595, GMax 5900/10000	345.00
240-518	57-2670	Rod - UMax795/1095, UMax II 695/795	284.50
240-521	57-2273	Sleeve - Ultra Max 795/1095, GMax 3900	202.50
240-525	57-2529	Sleeve - Gmax 5900, UltraMax 1595	285.50
240-580	58-2680	Piston Valve - GMax 7900	103.50
240-793	—	Order as: 223-540 (13-931) Airless Assy	—
240-794	—	1/4" x 50' Airless Hose Assy (See 223-541)	—
240-796	—	Order as: 214-703 (13-451) Hose Assy	—
240-797	—	Order as: 214-705 (13-453) Hose Assy	—
240-916	—	Replaced by 246-341 (20-2639)	—
240-918	20-2869	Inlet Seat - GH200/230/300, GMax 7900	129.50
240-919	57-2716	Rod - GMax 7900, GH 200, LL II/III/IV 200	379.00
240-921	57-2531	Sleeve - Gmax 7900, GMx 7900	314.00
241-926	13-2632	Hose Assembly - stPro, 190ES, 295st	29.10
243-070	14-2650	Outlet Filter, 30 Mesh - for Magnum Pumps	—
243-080	14-2685	Outlet Filter, 60 Mesh, Medium Length, Black	10.50
243-081	14-2686	Outlet Filter, 100 Mesh, Medium Length, Blue	10.50
243-082	14-2530	Inlet Strainer - 3/4" GH Thread	—
243-084	20-2719	Contractor Gun Filters, 50 & 100 Mesh (1 ea)	10.70
243-091	20-2359	Kit - 190ES	53.50
243-176	57-2775	Cylinder - 395/495 stPro, Ultra 695	94.75
243-177	57-2831	Cylinder - UltraMax 695, Ultimate Mx 695	130.00
243-181	58-2570	Piston Valve - UltraMax 695	82.50
243-190	20-2561	Intake Valve - 395/455/495stPro, UMax 695	51.25
243-192	—	Replaced by 244-194 (20-2428)	—
243-226	14-2687	Outlet Filter, 200 Mesh, Medium Length, Red	17.20
243-984	14-2795	Outlet Filter, 60 Mesh, Long, Black	13.70
244-065	14-2796	Outlet Filter, 100 Mesh, Long, Blue	12.30
244-066	14-2797	Outlet Filter, 200 Mesh, Long, Red	12.30

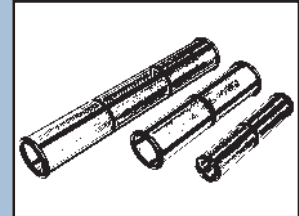

PART NO. 14-2675 60M
REPLACES 246-384 Short

PART NO. 14-2685 60M
REPLACES 243-080 Med

PART NO. 14-2695 60M
REPLACES 244-067 Long

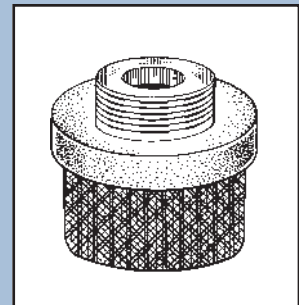

PART NO. 14-2530
REPLACES 243-082

GRACO LIST PRICES ARE BASED ON SINGLE UNIT PRICE IN GRACO U.S. PRICE LIST DATED 1/4/11

To order, contact your local
Paint Spray Equipment Dealer and ask for
Genuine Bedford Replacement Parts.

BEDFORD® Replacement Parts For . . . GRACO Equipment

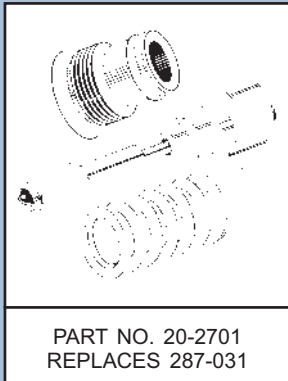
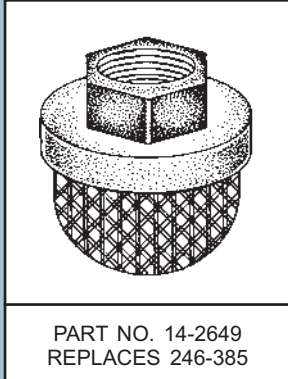

REPLACES GRACO PART NO.	BEDFORD PART NO.	DESCRIPTION	GRACO LIST PRICE (\$)
244-067	14-2695	Outlet Filter, 60 Mesh, Long, Black	11.60
244-068	14-2696	Outlet Filter, 100 Mesh, Long, Blue	11.60
244-069	14-2697	Outlet Filter, 200 Mesh, Long, Red	13.30
244-070	14-2794	Outlet Filter, 30 Mesh, Long, Gray	12.30
244-071	14-2694	Outlet Filter, 30 Mesh, Long, Gray	11.60
244-194	20-2428	Kit - 295st, 390, 395/495st Pro, Ult 395/495	60.50
244-196	—	Replaced by 248-212 (20-2662)	—
244-198	—	Replaced by 248-213 (20-2663)	—
244-199	20-2713	Intake Seat (1-1/4") - Seat, Ball & O-Ring	112.50
244-216	—	Order as: 240-518 (57-2670)	—
244-217	—	Order as: 240-517 (57-2672)	—
244-782	—	Replaced by 244-783 (13-2543)	—
244-783	13-2543	50' x 3/8" 4000PSI Pres Washer Hose w/QD	187.00
244-850	20-2947	Kit - 145cc Xtreme 600	138.50
244-851	20-2938	Kit - 180cc Xtreme 750	138.50
244-852	20-2961	Kit - 220cc Xtreme 900	138.50
244-890	55-2641	Teflon O-Rings (10-pack)	40.30
244-891	55-2966	Teflon O-Rings (10-pack)	44.60
244-892	55-2647	Teflon O-Rings (10-pack)	40.30
244-893	55-2645	Teflon O-Rings (10-pack)	40.30
244-894	55-2643	Teflon O-Rings (10-pack)	45.90
244-895	55-2536	Teflon O-Rings (10-pack)	34.40
244-896	55-2537	Teflon O-Rings (10-pack)	34.40
244-955	—	Replaced by 246-341 (20-2639)	—
245-414	—	Order as: 240-919 (57-2716)	—
245-525	20-2781	Kit - 1900	48.00
245-526	14-2787	Outlet Filter, 200 Mesh, Medium-Length, Red	10.00
245-527	14-2785	Outlet Filter, 60 Mesh, Medium-Length, Black	10.00
245-528	14-2786	Outlet Filter, 100 Mesh, Medium-Length, Blue	10.00
245-578	14-2760	Inlet Strainer, 3/4" GH Thread	8.50
246-341	20-2639	Kit - GH200, GMax 7900, HydraMax 225	137.50
246-351	20-2904	O-Ring Kit - Check Valve	30.70
246-354	55-2890	Solvent Resistant O-Rings (6-Pack)	54.75
246-355	20-2905	O-Ring Kit - AP Gun	117.00
246-360	55-2919	Teflon O-Rings, Flat Tip (3-Pack)	17.50
246-382	14-2676	Outlet Filter, 100 Mesh, Short, Blue	7.25
246-384	14-2675	Outlet Filter, 60 Mesh, Short, Black	7.25
246-385	14-2649	Inlet Strainer, 7/8" UNF Thd - Ultra 395/495	9.60
246-429	20-2757	Intake Seat Kit - 395/495 stPro, Ultra 695	114.50
248-000	20-2906	O-Ring Kit - MP Gun	98.50
248-095	55-2891	Solvent Resistant O-Rings (6-Pack)	60.00
248-096	55-2892	Solvent Resistant O-Rings (6-Pack)	38.30
248-128	55-2893	Solvent Resistant O-Rings (6-Pack)	36.90
248-129	55-2894	Solvent Resistant O-Rings (6-Pack)	30.30
248-130	55-2895	Solvent Resistant O-Rings (6-Pack)	47.90
248-131	55-2896	Solvent Resistant O-Rings (6-Pack)	35.60
248-132	55-2897	Solvent Resistant O-Rings (6-Pack)	66.25
248-133	55-2898	Solvent Resistant O-Rings (6-Pack)	51.50
248-134	55-2899	Solvent Resistant O-Rings (6-Pack)	30.20
248-135	55-2900	Solvent Resistant O-Rings (6-Pack)	73.75

GRACO LIST PRICES ARE BASED ON SINGLE UNIT PRICE IN GRACO U.S. PRICE LIST DATED 1/4/11

BEDFORD® Replacement Parts For . . . GRACO Equipment

To order, contact your local
Paint Spray Equipment Dealer and ask for
Genuine Bedford Replacement Parts.

REPLACES GRACO PART NO.	BEDFORD PART NO.	DESCRIPTION	GRACO LIST PRICE (\$)
248-136	55-2901	Solvent Resistant O-Rings (6-Pack)	73.75
248-137	55-2902	Teflon O-Rings (6-Pack)	28.70
248-138	55-2903	Solvent Resistant O-Rings (6-Pack)	78.75
248-206	—	Order as: 240-518 (57-2670)	—
248-207	—	Order as: 240-517 (57-2672)	—
248-209	—	Order as: 240-521 (57-2273)	—
248-210	—	Order as: 240-525 (57-2529)	—
248-212	20-2662	Kit - UltraMax II 695/795, GMax II 3900	78.25
248-213	20-2663	Kit - UMax II 1095/1595, GMax II 5900/10000	93.50
248-502	—	Order as: 239-932 (58-2564)	—
248-979	—	Order as: 240-921 (57-2531)	—
249-000	—	Order as: 240-919 (57-2716)	—
249-121	—	Order as: 240-921 (57-2531)	—
249-123	20-2917	Kit - GMax II 7900, UltraMax II 1895, Mark X	144.50
249-197	—	Order as: 218-131 (14-1484) 50M Filter	—
249-198	—	Order as: 218-133 (14-1485) 100M Filter	—
249-199	—	Order as: 287-032 (14-2664) 60M Filter	—
249-200	—	Order as: 287-032 (14-2665) 100M Filter	—
24B-732	55-2965	O-Rings, Solvent Resistant (10-Pack)	103.00
24B-733	55-2931	O-Rings, Solvent Resistant (10-Pack)	118.00
24C-499	—	Order as: Graco 178-898 (57-1403)	—
24C-508	—	Order as: 223-603 (57-1402)	—
255-204	20-2858	Kit - 190ES, 190LTS, 210ES, 210LTS	53.50
276-897	14-2759	Inlet Strainer, 7/8" UNF Thread	4.45
277-364	20-2865	Gasket Kit	4.70
287-031	20-2701	Kit - Contractor II & FTx II Spray Guns	66.75
287-032	14-2664	Gun Filter, 60 Mesh - Contractor II / FTxII	7.40
287-033	14-2665	Gun Filter, 100 Mesh - Contractor II / FTxII	7.40
287-034	14-2648	Gun Filters, 60 & 100 Mesh - Contractor II	14.40
287-078	—	Order as (1) ea: 243-091, 218-197, 176-751	—
287-079	—	Order as (1) ea: 222-588, 218-037, 178-945	—
287-813	20-2914	Kit - EH200, GH200, GH230, GH300	149.50
287-825	20-2774	Kit - Mark IV	80.00
288-716	14-2843	Inlet Strainer - 3/4"-GH Thread	8.35
288-747	14-2829	Outlet Filter, 40 Mesh	7.15
801-568	12-2524	3/8" NPT(f) Quick Disc Plug, Stainless Steel	20.20
801-569	12-2526	3/8" NPT(f) Quick Disconnect Coupler, Brass	20.20
803-157	12-2527	3/8" NPT(f) Quick Disc Coupler, Stainless St	77.00
M70628	54-25	Cup Lid Gasket, 2 Quart	—



PART NO. 14-2664 60M
REPLACES 287-032

PART NO. 14-2665 100M
REPLACES 287-033

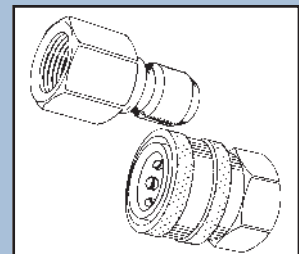

PART NO. 12-2524
REPLACES 801-568

PART NO. 12-2527
REPLACES 803-157

GRACO LIST PRICES ARE BASED ON SINGLE UNIT PRICE IN GRACO U.S. PRICE LIST DATED 1/4/11

To order, contact your local
Paint Spray Equipment Dealer and ask for
Genuine Bedford Replacement Parts.

BEDFORD® Replacement Parts For . . . H.E.R.O. Equipment

Quick Reference for . . . H.E.R.O. Pumps

PUMP MODEL	For the Bedford Replacement Part, refer to the following H.E.R.O. component P/N's:									
	DIAPHRAGM ASSEMBLY	INTAKE REPAIR PARTS					OUTGO REPAIR PARTS			
		HEAD & SEAT ASSEMBLY	INTAKE REPAIR KIT	SEAT	BALL	CAGE	OUTGO REPAIR KIT	SEAT	BALL	CAGE
75, 75W, 80, 90, 300GS/S/SL, 2000, 3000 Diaphragm Pumps	4-22C	4-4B	4-6652	6	17S 17	183S 18A	4-6655	11A-45 11A-4	11A-5S 11A-5	11A-6
1150G, 1150GS Diaphragm Pumps	4-622C	—	4-6653	6	17S	183S	4-6656 (See Note)	11A-45	11A-5S	11A-6
1000NC, 1100C, 1100NC Diaphragm Pumps	4-22C	4-4B	4-6651	6	17S 17	183S 18A	4-6655	11A-45 11A-4	11A-5S 11A-5	11A-6

Note: When ordering 4-6656 "Outgo Repair Kit", order 11A-45 "Outgo Seat" separately.

PUMP MODEL	Complete Fluid Section Repack / Repair Kits		
	REPLACES H.E.R.O. PART NO.	BEDFORD PART NO.	CONTAINS THE FOLLOWING ITEMS:
75, 75W, 80, 90, 300S, 300SL, 300GS 2000, 3000 Diaphragm Pumps	4-10-22-1502	20-1932	5 Intake O-Ring 17S Corrosion Resistant Intake Ball 4-22CRK Diaphragm Repair Kit 7C Outgo Valve Washer 11A-3CP Outgo Seat Crush Washer 11A-5 Nylon Outgo Ball
1150G, 1150GS Diaphragm Pumps	4-10-22-1507	20-1934	5 Intake O-Ring 17S Corrosion Resistant Intake Ball 4-622CRK Diaphragm Repair Kit 7C Outgo Valve Washer 11A-3CP Outgo Seat Crush Washer 11A-5S Corrosion Resistant Outgo Ball
1000NC, 1100C, 1100NC Diaphragm Pumps	4-10-22-1503	20-1933	5 Intake O-Ring 17 Nylon Intake Ball 4-22CRK Diaphragm Repair Kit 7C Outgo Valve Washer 11A-3CP Outgo Seat Crush Washer 11A-5 Nylon Outgo Ball
400, 401, 500, 501, 6000 Piston Pumps	4-02-40-2510	20-2051	02-40-2003 Intake Valve O-Ring 02-40-2004 Lower Ball (Intake) 02-40-2007 Crush Washer 02-40-2010 Backup Washer 02-40-2018 Upper Ball (Piston) 4-02-40-2503 Upper Packing Set 4-02-40-2509 Lower packing Set

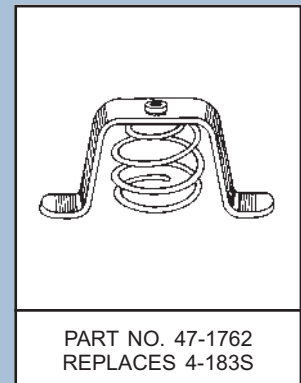
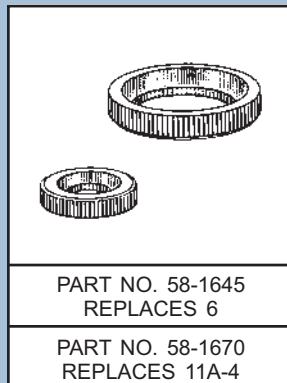
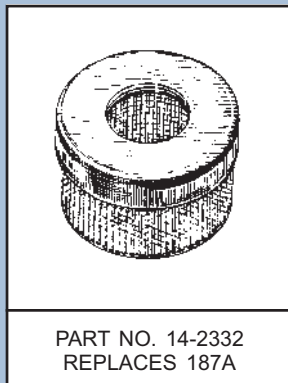

BEDFORD® Replacement Parts

For . . . H.E.R.O. Equipment

To order, contact your local
Paint Spray Equipment Dealer and ask for
Genuine Bedford Replacement Parts.

REPLACES H.E.R.O. PART NO.	BEDFORD PART NO.	DESCRIPTION	H.E.R.O. LIST PRICE (\$)
02-22-2006	0-2003	Intake O-Ring, Urethane	4.83
02-22-2007	0-2004	Intake O-Ring, Viton	5.46
02-22-2009	10-2005	Intake Washer, Crush	5.72
02-40-2003	15-2033	Intake Valve O-Ring, Teflon	7.14
02-40-2004	9-2034	Ball, Intake Valve	4.41
02-40-2007	10-2035	Intake Washer, Crush	5.10
02-40-2010	10-2036	Backup Washer, Piston Valve	9.15
02-40-2018	9-2037	Ball, Piston Valve	2.14
02-40-2019	57-2334	Rod - 400, 500, 6000 Pumps	—
1-3-WHIP	—	Replaced by 3-WHIPEND (13-792)	—
3-WHIPEND	13-792	3' x 3/16" Airless Hose Assembly	38.97
4-02-40-2019	—	Order as: (1) 02-40-2019 (57-2334)	—
4-02-40-2503	20-2038	Upper Packing Set - 400, 500, 6000	—
4-02-40-2509	20-2044	Lower Packing Set - 400, 500, 6000	—
4-02-40-2510	20-2051	Kit - 400, 500, 6000 Series Pumps	78.48
4-10-22-1502	20-1932	Kit - 75W, 80, 90, 300S/SL, 2000	74.36
4-10-22-1503	20-1933	Kit - 1100NC, 1000NC	71.03
4-10-22-1507	20-1934	Kit - 1150G, 1150GS	90.49
4-4B	47-1953	Intake Head Assembly (SS) - for 3/8" bolts	420.86
4-22C	20-1725	Diaphragm Assembly - Electric Models	83.25
4-22CRK	20-1632	Kit - Diaphragm Repair, Electric Models	35.45
4-183S	47-1762	Intake Ball Cage, Spring Loaded	34.22
4-606RK	20-2538	Kit - Prime/Bleed Valve	55.77
4-622C	20-1888	Diaphragm Assembly - Gas Models	132.32
4-622CRK	20-1889	Kit - Diaphragm Repair - Gas Models	47.36
4-6650	20-1722	Kit - Intake Repair	63.88
4-6651	20-1729	Kit - Intake Overhaul	148.28
4-6652	20-1763	Kit - Intake Repair	89.24
4-6653	20-1764	Kit - Intake Overhaul	179.30
4-6654	20-1723	Kit - Outgo Repair	49.20
4-6655	20-1724	Kit - Outgo Overhaul	97.03
4-6656	20-1721	Kit - Outgo Repair	16.66
5	0-1588	O-Ring	3.17
5V	0-1589	Intake O-Ring, Viton	5.49
6	58-1645	Seat, Intake Valve, 3/4"	89.12
7C	10-1590	Washer, Outgo Valve, Copper	2.24
10-55-4402	58-2232	Diffuser Assy, ASM 400 Gun, "F" Thread	52.02
10-55-4404	47-2227	Ball & Plunger Assembly, ASM 400 Gun	58.17
10-55-4405	47-2229	Ball Holder Assembly, ASM 400 Gun	32.04
10-55-4412	6-2223	External Seal, ASM 400 Gun	3.11
10-55-4425	55-2226	Valve Stem Locknut (3-pack), ASM 400 Gun	9.32
10-55-4426	20-2233	Kit - ASM 400 (Diffuser & Ball Holder)	70.51
10-55-4427	20-2234	Kit - ASM 400 (Diffuser, Ball Holder, Plunger)	97.14
10-55-4428	47-2235	Plunger Assembly, ASM 400 Gun	38.17
11A-3CP	10-1591	Washer, Outgo, Copper, Crush	2.24
11A-4	58-1670	Seat, Outgo Valve, 3/8"	49.48
11A-45	58-1740	Seat, Outgo Valve (90°)	51.65
11A-5	9-1592	Ball, Outgo, Nylon, 3/8"	3.05
11A-5S	9-1593	Ball, Outgo, 3/8" Corrosion Resistant	6.11
11A-6	17-1705	Cage, Outgo Ball	19.80

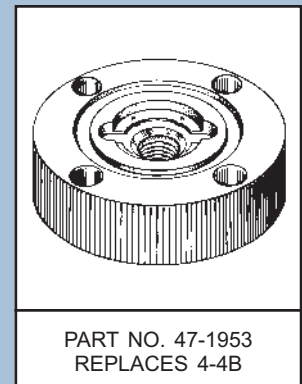
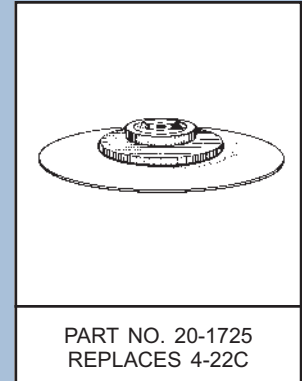

H.E.R.O. LIST PRICES ARE BASED ON SINGLE UNIT PRICE IN H.E.R.O. U.S. PRICE LIST DATED 1/1/11

To order, contact your local
Paint Spray Equipment Dealer and ask for
Genuine Bedford Replacement Parts.

BEDFORD® Replacement Parts For . . . H.E.R.O. Equipment

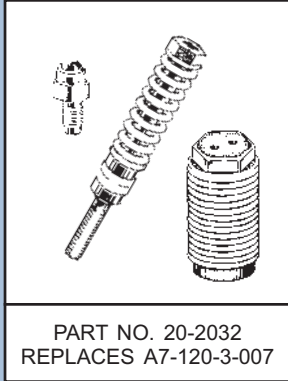

REPLACES H.E.R.O. PART NO.	BEDFORD PART NO.	DESCRIPTION	H.E.R.O. LIST PRICE (\$)
11A-7	23-1600	Spring, Outgo Valve	18.85
17	9-1594	Ball, Intake, Nylon, 3/4"	6.11
17S	9-1595	Ball, Intake, 3/4" Corrosion Resistant	13.45
18A	17-1708	Cage, Intake Ball	27.73
19A	23-1627	Spring, Intake Valve, 1-7/8"	22.06
27C-2	9-1728	Ball, PC Valve	3.19
114	13-932	50' x 1/4" Airless Hose Assembly	107.18
115	13-931	25' x 1/4" Airless Hose Assembly	55.75
117	13-453	50' x 3/8" Airless Hose Assembly	262.96
187A	14-2332	Inlet Strainer - 3/4" NPT Thread	—
187F	—	Order as: 187A (14-2332)	—
A7-120-11	58-2001	Valve Spring Unit - 007 Gun	141.84
A7-120-2-007	20-2031	Kit - 007 Gun (Ball Holder & Seal)	—
A7-120-21	19-2007	Lock nut	.46
A7-120-3-007	20-2032	Kit - 007 Gun (Complete)	—
A7-120-33	2-2029	Seal, Teflon	—
A7-120-35	58-2022	Valve Seat - 007 Gun	151.41
A7-120-37	58-2024	Ball Holder	119.52

H.E.R.O. LIST PRICES ARE BASED ON SINGLE UNIT PRICE IN H.E.R.O. U.S. PRICE LIST DATED 1/11/11

To order, contact your local
Paint Spray Equipment Dealer and ask for
Genuine Bedford Replacement Parts.

BEDFORD® Replacement Parts For . . . SHARPE Equipment

REPLACES SHARPE PART NO.	BEDFORD PART NO.	DESCRIPTION	SHARPE LIST PRICE (\$)
10326	8-1807	Head Attach Gasket (1-20-28)	5.25
10332	44-1800	Trigger Shaft (1-20-34)	8.50
10333	19-1801	Trigger Screw (1-20-35)	5.25
16000	20-1794	Kit - 71 & 75PI Guns (1-70RK)	38.75
16100	8-1802	Tip Gasket (1-71-01)	5.25
16137	55-1803	Packings, Set of 2 (1-71-11A)	5.25
16139	8-1804	Packing (1-71-13)	5.25
16147	12-1805	Packing Nut (1-71-21)	6.25
16150	23-1806	Needle Spring (1-71-24)	5.25
16162	8-1808	Air Valve Packing (1-71-37)	5.25
16163	8-1809	Gasket (1-71-38)	5.25
16166	47-1810	Air Valve Assembly (1-71-41X)	—
16167	23-1811	Air Valve Spring (1-71-42)	5.25
16175	19-1812	"E" Clip (1-71-50)	5.25
25032	23-1813	Needle Spring (1-775-24)	5.25
25066	47-1814	Air Valve Assembly (1-775-41X)	13.00
25196	20-1795	Kit - 775PI Gun (1-775RK)	41.00

SHARPE LIST PRICES ARE BASED ON SINGLE UNIT PRICE IN SHARPE U.S. PRICE LIST DATED 1/11/12

BEDFORD® Replacement Parts For . . . TITAN / SPEEFLO Equipment

To order, contact your local
Paint Spray Equipment Dealer and ask for
Genuine Bedford Replacement Parts.

REPLACES TITAN PART NO.	BEDFORD PART NO.	DESCRIPTION	TITAN LIST PRICE (\$)
0516731	—	Order as: Wagner 89960 (Bedford 55-894)	—
0516732	—	Order as: Wagner 89959 (Bedford 55-893)	—
0516733	—	Order as: Wagner 89958 (Bedford 55-892)	—
0516734	—	Order as: Wagner 89957 (Bedford 55-891)	—
0516746	20-2773	Kit - XT440	—
0555002	—	Replaced by 705-103 (44-2809)	—
103-624	14-905	Screen, Inlet Sump - 50 Mesh	11.47
103-625	14-2297	Rock Catcher Assembly - 1" OD Tube	24.02
103-627	14-2299	Rock Catcher Assembly - 1-1/4" OD Tube	25.78
103-628	14-904	Screen, Inlet Sump - 30 Mesh	11.82
106-002	20-1673	Packing Set (L/PE)	49.42
106-011	58-2405	Piston Valve - PowrTwin 3500 & 4500, Scout	129.97
106-014	0-1679	O-Ring	2.74
106-015	15-1681	Teflon O-Ring	8.80
106-050	20-1685	Kit - PowrTwin JR, Scout, Super Scout (L/PE)	92.56
106-051	—	Replaced by 106-050 (20-1685)	—
106-116	44-1683	Sleeve, Spring	11.51
107-029	57-2270	Rod - PowrTwin 3500/4500	228.77
107-051	20-1857	Kit - PowrTwin 3500/4500 (L/PE)	90.79
107-060	8-2745	Gasket, Seat	5.36
107-501	—	Order (1) each: 107-029, 107-936, 107-051	—
107-936	57-2343	Cylinder - PowrTwin 3500/4500	301.39
107-946	—	Order as: 107-936 (57-2343)	—
108-021	—	Order as: 107-029 (57-2270)	—
108-940	—	Order as: 107-936 (57-2343)	—
138-019	8-1210	Gasket	20.66
138-025	—	Replaced by 138-225 (9-1183)	—
138-031	8-567	Nylon Gasket	2.36
138-052	20-570	Packing Set - Upper (L/PE)	58.15
138-053	20-1213	Packing Set - Upper (L/T)	58.15
138-054	20-1858	Packing Set - Upper (T/PE)	—
138-153	20-571	Packing Set - Lower (L/PE)	58.15
138-154	20-1214	Packing Set - Lower (L/T)	58.15
138-225	9-1183	SS Ball	3.33
138-252	20-1851	Packing Set - Upper (L/T)	58.15
138-253	20-1852	Packing Set - Lower (L/T)	58.15
138-256	—	Replaced by 138-053 (20-1213)	—
138-257	—	Replaced by 138-154 (20-1214)	—
138-258	—	Replaced by 138-052 (20-570)	—
138-259	—	Replaced by 138-153 (20-571)	—
138-340	9-534	Ball	6.68
138-520	20-1869	Packing Set - Upper (T)	58.15
138-521	—	Replaced by 138-520 (20-1869)	—
138-522	20-1870	Packing Set - Lower (T)	58.15
138-523	20-1859	Packing Set - Lower (T/PE)	58.15
138-917	57-2180	Rod - PowrTwin Classic, Atlas 30, Cmdr 60	224.28
138-941	—	Replaced by 143-945 (58-2327)	—
140-009	0-565	Foot Valve O-Ring	1.67
140-051	20-572	Kit - PowrTwin, Commander 60 (L/PE)	117.48
140-052	20-1215	Kit - PowrTwin, Commander 60 (L/T)	117.48

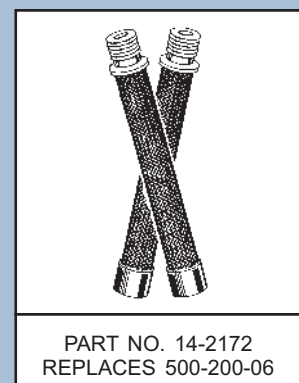
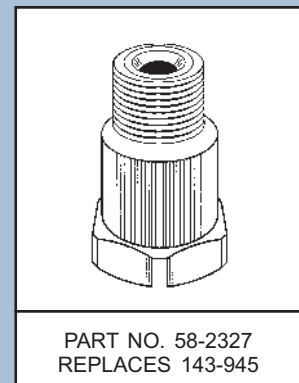
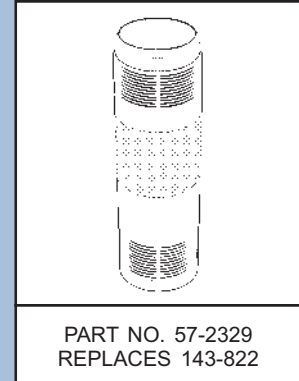

TITAN / SPEEFLO LIST PRICES ARE BASED ON SINGLE UNIT PRICE IN TITAN / SPEEFLO U.S. PRICE LIST DATED 3/1/11

To order, contact your local
Paint Spray Equipment Dealer and ask for
Genuine Bedford Replacement Parts.

BEDFORD® Replacement Parts For . . . TITAN / SPEEFLO Equipment

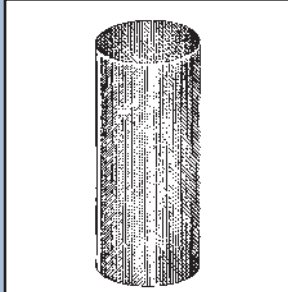

PART NO. 14-905
REPLACES 103-624

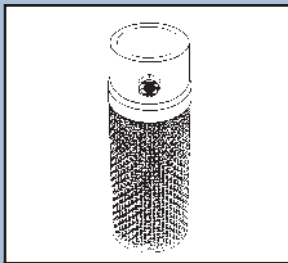

PART NO. 14-2297
REPLACES 103-625

PART NO. 14-2299
REPLACES 103-627

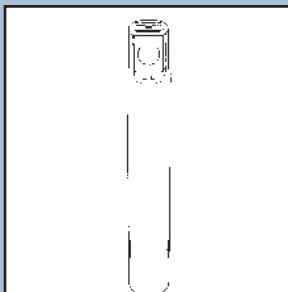

PART NO. 57-2274
REPLACES 143-117

REPLACES TITAN PART NO.	BEDFORD PART NO.	DESCRIPTION	TITAN LIST PRICE (\$)
140-053	20-1871	Kit - PowrTwin, Commander 60 (T)	133.43
141-007	0-2441	O-Ring	1.29
143-019	10-1849	Retaining Ring	10.60
143-025	15-2699	Intake Seat O-Ring (XLT)	2.01
143-050	20-1853	Kit - PowrTwin 5500 (L/PE)	124.32
143-051	—	Replaced by 143-050 (20-1853)	—
143-117	57-2274	Rod - PowrTwin 5500	295.48
143-127	—	Order as: Speeflo 143-117 (57-2274)	—
143-500	—	Order (1) ea: 143-050, 143-117, 143-822	—
143-822	57-2329	Cylinder - PowrTwin 5500	354.82
143-945	58-2327	Piston Valve - PowrTwin, PT5500, Cmdr 60	117.48
144-050	20-2152	Kit - PowrTwin 8900GH, 10000, 12000GH	124.32
144-051	20-2967		156.53
144-117	57-2594	Rod - PowrTwin 8900GH / 10000 / 12000GH	354.82
144-500	—	Order (1) ea: 144-050, 144-117, 144-822	—
144-822	57-2587	Cylinder - PT 8900GH / 10000 / 12000GH	414.15
145-031	15-1473	Teflon O-Ring	14.08
145-051	20-1471	Kit - PowrTwin Classic, Atlas, Ensign (L/PE)	158.99
145-052	20-1472	Kit - PowrTwin Classic, Atlas, Ensign (L/T)	158.99
145-054	—	Replaced by 145-052 (20-1472)	—
145-055	—	Replaced by 145-051 (20-1471)	—
145-060	—	Replaced by 145-051 (20-1471)	—
145-061	—	Replaced by 145-052 (20-1472)	—
145-500	—	Order (1) ea: 145-051, 145-922, 138-917	—
145-501	—	Order (1) ea: 145-052, 145-922, 138-917	—
145-502	—	Order (1) ea: 148-050, 145-922, 138-917	—
145-922	57-2345	Cylinder - PT Classic, Atlas 30, Ensign 12	361.36
148-050	20-1854	Kit - 148 Series Pumps (L/T)	186.31
148-051	20-1860	Kit - 148 Series Pumps (T/PE)	186.31
160-124	—	Order as: (24) pcs 160-100 (14-516)	—
160-524	—	Order as: (24) pcs 160-500 (14-517)	—
173-133	15-1187	Teflon O-Ring	17.35
174-001	15-562	Teflon O-Ring	13.01
174-025	20-1698	Packing Set - Lower (L/T)	68.25
174-050	20-573	Kit - Ranger 3:1 (L/T)	153.64
174-051	20-865	Kit - Ranger 3:1 (L/T)	149.06
174-052	20-1692	Kit - Ranger 3:1, Trident 3:1, 174-554 Pump (T)	163.87
174-055	20-1699	Kit - Ranger 3:1 (L/T/SS)	—
174-056	20-1701	Kit - Trident 3:1, 174-554 Pump (L/T)	162.20
174-058	20-1206	Kit - Ranger 3:1, Trident 3:1, 174-554 Pump (T)	200.41
174-059	—	Replaced by 174-058 (20-1206)	—
175-001	20-574	V-Packing Set - Upper (L/T)	80.78
175-002	20-589	Cup Packing Set - Lower (L/T)	40.05
175-121	—	Replaced by 178-320 (20-1203)	—
175-220	—	Replaced by 178-320 (20-1203)	—
175-222	20-1204	Cup Packing Set - Lower (T)	—
178-001	20-1270	Packing Set - Upper (L/PE)	105.85
178-007	—	Replaced by 178-700 (9-477)	—
178-320	20-1203	Packing Set - Upper (T/SS)	57.81
178-420	—	Replaced by 178-420A (20-1702)	—

TITAN / SPEEFLO LIST PRICES ARE BASED ON SINGLE UNIT PRICE IN TITAN / SPEEFLO U.S. PRICE LIST DATED 3/1/11

BEDFORD® Replacement Parts For . . . TITAN / SPEEFLO Equipment

To order, contact your local
Paint Spray Equipment Dealer and ask for
Genuine Bedford Replacement Parts.

REPLACES TITAN PART NO.	BEDFORD PART NO.	DESCRIPTION	TITAN LIST PRICE (\$)
178-420A	20-1702	Packing Set - Upper (L/T)	80.78
178-700	9-477	Ball	24.73
180-002	20-576	Packing Set - Lower (L/T)	82.21
180-122	—	Replaced by 180-322 (20-1690)	—
180-124	—	Replaced by 180-322 (20-1690)	—
180-322	20-1690	Packing Set - Lower (T)	73.73
182-007	15-561	Teflon O-Ring	14.77
182-050	20-579	Pump Service Kit Minor (L/T)	183.89
182-921	58-2605	Piston Valve - HydraPro III/IV, Cmdr, Admrl	162.24
183-001	20-1279	Packing Set - Lower (L/PE)	127.72
183-050	—	Replaced by 185-051 (20-1319)	—
183-051	—	Replaced by 185-050 (20-1318)	—
183-052	—	Replaced by 185-052 (20-1691)	—
183-053	—	Replaced by 185-050 (20-1318)	—
183-230	0-880	O-Ring	3.04
183-930	57-2341	Cylinder - HydraPro IV/Super, Cmdr 30, Boss	532.82
185-050	20-1318	Kit - HydraPro III/IV/Super, Admrl, Boss (L/PE)	142.40
185-051	20-1319	Kit - HydraPro III/IV/Super, Admrl, Boss (L/T)	142.40
185-052	20-1691	Kit - HydraPro III/IV/Super, Admrl, Boss (T)	142.40
185-984	57-2272	Rod - HydraPro IV/Super, Admrl, Boss, Cmdr	414.15
200-551	12-403	Swivel Adapter 1/4" NPT(m) x 3/8" NPS(f)	—
200-555	12-465	Swivel Adapter 1/2" NPT(m) x 1/2" NPS(f)	12.24
201-520	20-2681	Kit - XLT Intake O-Ring & Outlet Washer	14.13
201-525	20-2746	O-Ring & Gasket, Seats	18.40
203-316	13-792	3' x 3/16" Airless Hose Assembly	55.13
211-029	—	Replaced by 211-129 (9-1697)	—
211-129	9-1697	Ball	22.29
221-008	0-2103	O-Ring	1.18
221-011	0-2104	O-Ring	1.18
221-012	0-2105	O-Ring	1.31
222-012	6-2106	Backup Ring	1.13
226-001	19-2089	Locknut, LX-80	1.65
227-027	12-2138	Plug, Manifold	1.29
227-100	28-759	Gauge, 1/4" NPT Btm Mnt, 0-100 PSI, 2"	30.55
234-702	0-1193	O-Ring	1.14
235-026	0-2442	O-Ring	3.22
235-027	16-2436	Piston Seal	15.90
235-028	16-2438	Rod Seal	18.95
235-050	20-2439	Hydraulic Motor Kit - PTwin 3500/4500/5500	47.25
236-011	8-2698	Piston Seat Washer (XLT)	6.34
236-032	8-2772	Seal, Outlet Seat - XLT	7.59
240-001	20-2390	Packing Set - Hydra M 4000 (Ctr)	101.51
245-050	20-2396	Kit - Hydra M 4000 (Ctr)	236.15
314-180	9-876	Ball	56.81
325-005	23-2446	Trip Spring	3.70
420-065	—	Order as: 4-1/2' of Cut-Length 3/4" Hose	—
420-070	13-2558	1" x 5' Fluid Hose, Cut Length, No Fittings	62.00
425-029	—	Replaced by 858-812 (19-1217)	—
426-016	0-1196	O-Ring	11.82
426-051	22-864	Sealant	8.68

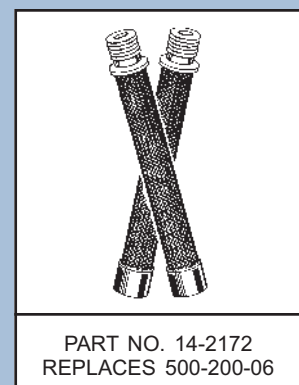
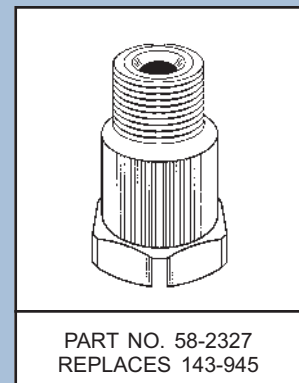
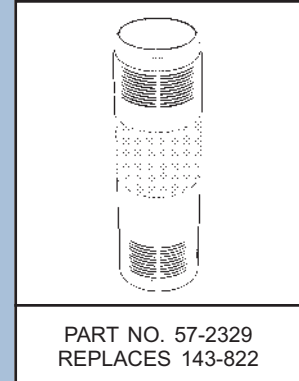

TITAN / SPEEFLO LIST PRICES ARE BASED ON SINGLE UNIT PRICE IN TITAN / SPEEFLO U.S. PRICE LIST DATED 3/1/11

To order, contact your local
Paint Spray Equipment Dealer and ask for
Genuine Bedford Replacement Parts.

BEDFORD® Replacement Parts For . . . TITAN / SPEEFLO Equipment

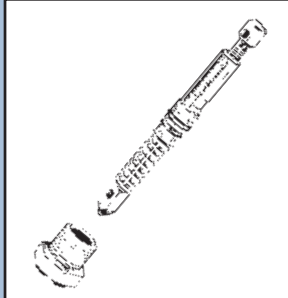

PART NO. 20-2088
REPLACES 520-025



PART NO. 20-2095
REPLACES 580-034

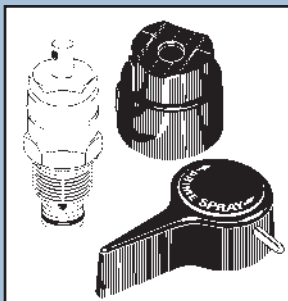

PART NO. 29-2600
REPLACES 700-258

REPLACES TITAN PART NO.	BEDFORD PART NO.	DESCRIPTION	TITAN LIST PRICE (\$)
431-019	20-2872	O-Ring / Backup Ring Set	5.14
431-032	0-2443	O-Ring	4.19
432-628	—	Replaced by 872-005 (8-1657)	—
441-152	0-2444	O-Ring	3.87
441-217	0-2445	O-Ring	2.09
500-200-03	14-2171	Gun Filter (2 pcs), 30 Mesh, Coarse, Green	13.17
500-200-06	14-2172	Gun Filter (2 pcs), 60 Mesh, Medium, White	13.17
500-200-10	14-2173	Gun Filter (2 pcs), 100 Mesh, Fine, Yellow	13.17
500-200-15	14-2174	Gun Filter (2 pcs), 150 Mesh, Extra-Fine, Red	13.17
520-018	—	Replaced by 520-093 (58-2620)	—
520-020	10-2083	Washer	1.72
520-023	58-2087	Seal Assembly	57.91
520-025	20-2088	Kit - SGX-20 Gun	87.66
520-048	58-2086	Diffuser - SGX-20 Gun	36.49
520-093	—	Replaced by 520-099 (58-2620)	—
520-099	58-2620	Diffuser - LX-80	41.47
540-030	14-2161	Gun Filter, 30 Mesh, Green	6.05
540-060	14-2162	Gun Filter, 60 Mesh, White	6.05
540-100	14-2163	Gun Filter, 100 Mesh, Yellow	6.05
540-150	14-2164	Gun Filter, 150 Mesh, Red	6.05
541-025	3-559	Leather Cup Packing	—
541-026	17-618	Washer	—
541-125	4-560	Teflon Cup Packing	—
541-126	8-1198	Washer	—
550-271	—	Order as: Wagner 89958 (55-892)	—
550-272	—	Order as: Wagner 89957 (55-891)	—
550-273	—	Order as: Wagner 89959 (55-893)	—
550-274	—	Order as: Wagner 89960 (55-894)	—
550-483	—	Order as: Wagner 89958 (55-892)	—
550-484	—	Order as: Wagner 89957 (55-891)	—
550-485	—	Order as: Wagner 89959 (55-893)	—
550-486	—	Order as: Wagner 89960 (55-894)	—
558-015	—	Replaced by 872-005 (8-1657)	—
560-038	8-2834	Seal - Outlet Filter / Gun Handle	2.14
568-051	20-852	Packing Set - Upper (L/T)	67.69
568-052	20-585	Packing Set - Lower (L/T)	72.21
568-521	20-586	Packing Set - Upper (T)	78.49
568-522	20-587	Packing Set - Lower (T)	87.84
569-016	9-652	Ball	3.70
569-017	9-653	Ball	—
569-021	9-654	Ball	3.38
569-023	10-851	Gasket	6.42
569-120	8-598	Gasket	7.55
580-017	—	Replaced by 580-510 (58-2094)	—
580-034	20-2095	Kit - LX-80 & LX-80II Guns	76.38
580-510	58-2094	Needle Seal Assembly - LX-80 Gun	59.30
581-059	14-831	Gun Filter, 30 Mesh, Coarse (Green)	6.54
581-060	14-832	Gun Filter, 50 Mesh, Medium (White)	6.54
581-061	14-834	Gun Filter, 180 Mesh, Extra-Fine (Red)	6.54
581-062	14-833	Gun Filter, 100 Mesh, Fine (Yellow)	6.54

TITAN / SPEEFLO LIST PRICES ARE BASED ON SINGLE UNIT PRICE IN TITAN / SPEEFLO U.S. PRICE LIST DATED 3/1/11

BEDFORD® Replacement Parts For . . . TITAN / SPEEFLO Equipment

To order, contact your local
Paint Spray Equipment Dealer and ask for
Genuine Bedford Replacement Parts.

REPLACES TITAN PART NO.	BEDFORD PART NO.	DESCRIPTION	TITAN LIST PRICE (\$)
694-003	0-564	O-Ring	2.09
694-051	20-853	Kit - Ensign 35:1 (L/T)	133.35
700-024	0-2275	O-Ring	10.85
700-072	49-2190	Upper Seal - 440e, 447ex, 660ex, 690gx	23.54
700-201	0-2107	O-Ring	3.56
700-203	22-2206	Grease	3.28
700-240	—	Replaced by 700-258 (29-2600)	—
700-248	12-2617	Retainer, Drain Valve	3.50
700-250	58-2608	Stem Assembly, Drain Valve	19.17
700-252	47-2610	Cam Base, Drain Valve	18.90
700-258	29-2600	Bypass Valve Assembly	75.95
700-499	0-2108	O-Ring	1.88
700-537	10-2109	Bypass Gasket	1.31
700-580	57-2264	Rod - Epic 440e, 447ex, 660ex, 690gx	91.45
700-583	58-2100	Inlet Valve - 440e, 447ex, 660ex, 690gx	42.11
700-585	58-2102	Outlet Valve - 440e, 447ex, 660ex, 690gx	25.26
700-587	8-2207	Upper Guide	5.04
700-601A	49-2187	Seal - 440e, 447ex, 660ex, 690gx, 440HP	26.55
700-603	—	Replaced by 700-072 (49-2190)	—
700-608	58-2134	Foot Valve Assy - 440e, 447ex, 660ex, 690gx	85.00
700-697	46-2619	Valve Handle, Drain Valve	9.92
700-721	0-2111	O-Ring	1.13
700-759	19-2618	Grooved Pin, Drain Valve	2.37
700-790	—	Replaced by 702-130 (20-2208)	—
700-793	21-2203	Piston Guide Tool	1.72
700-804	8-2110	Gasket	1.13
700-805	14-2081	Inlet Screen - 440e, 447ex, 660ex, 690gx	10.74
700-815	—	Replaced by 702-140 (20-2209)	—
700-821	8-2135	Foot Valve Seal	3.32
700-823	19-2611	Dowel Pin, 1/8" x 3/8", Cam Base	1.24
700-881	8-2136	Gasket	2.64
700-897	15-2137	Teflon O-Ring	4.76
701-031	7-888	Air Valve Packing	—
702-130	20-2208	Packing Kit - 440e, 447ex, 660ex, 690gx	54.25
702-140	20-2209	Rebuild Kit - 440e, 447ex, 660ex, 690gx	95.07
702-303	15-2528	Teflon O-Ring	3.51
704-089	—	Replaced by 704-560 (57-2720)	—
704-090	—	Replaced by 704-560 (57-2720)	—
704-109	0-2887	O-Ring, Solvent Resistant	15.70
704-113	20-2397	Kit - Epic 300HP	41.36
704-121	0-2448	O-Ring	2.10
704-289	44-2738	Bushing, Piston Guide	23.35
704-297	15-2762	Teflon O-Ring	6.87
704-547	49-2728	Lower Packing	35.60
704-551A	57-2700	Rod - Epic Pumps	91.45
704-557	46-2692	Ball Cage, Outlet Valve	4.51
704-558	58-2691	Outlet Valve Seat	24.33
704-560	57-2720	Piston Rod Assembly - Epic Pumps	130.53
704-564	49-2729	Upper Packing Assembly & Tool	23.54
704-584	—	Replaced by 762-057 (15-2122)	—

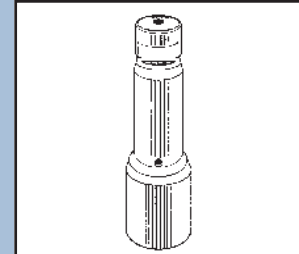

PART NO. 57-2264
REPLACES 700-580

PART NO. 57-2720
REPLACES 704-560

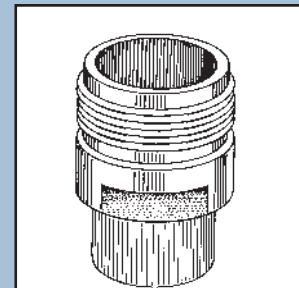

PART NO. 58-2134
REPLACES 700-608

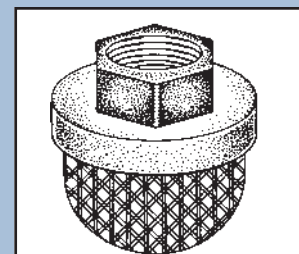

PART NO. 14-2081
REPLACES 700-805 3/4"

PART NO. 14-2082
REPLACES 710-046 1-5/16"

TITAN / SPEEFLO LIST PRICES ARE BASED ON SINGLE UNIT PRICE IN TITAN / SPEEFLO U.S. PRICE LIST DATED 3/1/11

To order, contact your local
Paint Spray Equipment Dealer and ask for
Genuine Bedford Replacement Parts.

BEDFORD® Replacement Parts For . . . TITAN / SPEEFLO Equipment

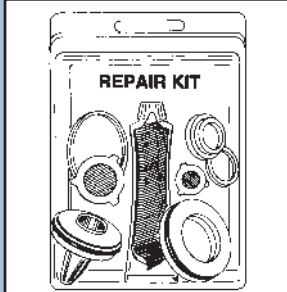

PART NO. 20-2209
REPLACES 702-140

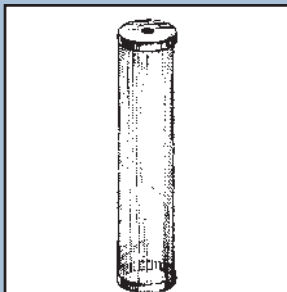

PART NO. 14-2097
REPLACES 730-067

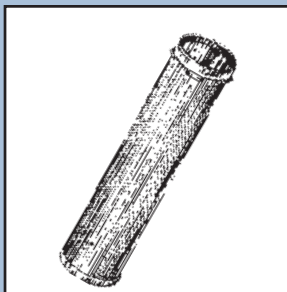

PART NO. 14-2101
REPLACES 761-043

REPLACES TITAN PART NO.	BEDFORD PART NO.	DESCRIPTION	TITAN LIST PRICE (\$)
704-586	20-2727	Kit - 440ix, 640ix, 660ix	64.08
704-587	12-2693	Retainer, Outlet Valve Seat	17.80
705-103	44-2809	Adapter	10.39
705-105	44-2811	Guide, Piston	10.67
705-120A	57-2780	Rod Assy - 740i, 740ix, PowrLiner 2800M	267.00
710-046	14-2082	Inlet Screen - E15, E20, G40, G55, PM5500	15.13
710-069	—	Replaced by 227-027 (12-2138)	—
710-196	0-2139	O-Ring	4.76
711-605	8-2148	Tip Gasket, 1/16"	1.18
711-606	20-2149	Tip Gasket, 1/16" (12 pcs)	10.45
711-611	8-2156	Tip Gasket, 1/8"	.34
711-612	20-2157	Tip Gasket, 1/8" (12 pcs)	9.95
730-067	14-2097	Outlet Filter, 60M - 660ex, 690gx, Pro 690	5.92
730-067-10	14-2098	Outlet Filter, 100M - 660ex, 690gx, Pro 690	5.92
730-067-30	14-2096	Outlet Filter, 30M - 660ex, 690gx, Pro 690	5.92
730-401	20-2242	Kit - 440HP, 447HP, 660HPx	56.10
730-506	—	Replaced by 704-560 (57-2720)	—
730-509	—	Replaced by 704-289 (44-2738)	—
738-004	10-1207	Gasket	12.58
738-021	0-1192	O-Ring	1.44
738-213	23-1197	Trip Spring	9.99
738-224	0-1216	O-Ring	16.96
742-001	0-1195	O-Ring	1.44
742-051	20-1218	Air Motor Kit - Cmdr 30/60, PowrMastic	96.66
742-223	0-563	Valve Sleeve O-Ring	2.57
753-024	22-539	Teflon Sealant Tape	—
761-043	14-2101	Outlet Filter, 60 Mesh - E15, E20, G40, G55	9.86
761-057	15-2112	Teflon O-Ring	3.40
761-058	15-2113	Teflon O-Ring	4.76
761-072	49-2342	Upper Packing with Installation Tool	34.35
761-076	8-2140	Lower Seal	5.61
761-079	20-2115	Upper Seat & O-Ring - E20, G55, PM5500	55.94
761-080	20-2117	Lower Seat & O-Ring - E20, G55, PM5500	—
761-103	15-2118	Teflon O-Ring	4.62
761-111	8-2141	Upper Seal	3.45
761-136	49-2193	Upper Packing Assembly	23.40
761-138	49-2196	Lower Seal - E20, G55, Promark 5500	21.95
761-144	9-2119	Ball, Upper	1.96
761-145	9-2120	Ball, Lower	6.74
761-175	20-2210	Kit - E20, G55, Promark 5500	106.27
761-247	23-2142	Core, Filter Manifold	31.43
761-273	21-2204	Piston Guide Tool	6.44
761-456	15-2121	Teflon O-Ring	6.46
762-057	15-2122	Teflon O-Ring	3.23
762-058	15-2123	Teflon O-Ring	4.40
762-072	49-2338	Upper Packing with Installation Tool	35.85
762-076	8-2143	Lower Seal	5.81
762-080	20-2127	Lower Seat & O-Ring - E15, G40	49.91
762-103	15-2128	Teflon O-Ring	4.39
762-111	8-2144	Upper Seal	3.25

TITAN / SPEEFLO LIST PRICES ARE BASED ON SINGLE UNIT PRICE IN TITAN / SPEEFLO U.S. PRICE LIST DATED 3/1/11

BEDFORD® Replacement Parts For . . . TITAN / SPEEFLO Equipment

To order, contact your local
Paint Spray Equipment Dealer and ask for
Genuine Bedford Replacement Parts.

REPLACES TITAN PART NO.	BEDFORD PART NO.	DESCRIPTION	TITAN LIST PRICE (\$)
762-136	—	Replaced by 762-072 (49-2338)	—
762-137	58-2437	Intake Valve Seat	30.32
762-138	49-2202	Lower Seal - E15, G40	21.95
762-144	9-2129	Ball, Upper	2.14
762-145	9-2130	Ball, Lower	9.91
762-175	20-2211	Kit - E15, G40	97.76
762-273	21-2205	Piston Guide Tool - E15, G40	6.28
770-389	20-2150	O-Ring Packing Kit - HVLP Guns	16.62
770-401	0-2145	O-Ring	6.79
770-402	0-2146	O-Ring	4.22
770-410	0-2147	O-Ring	4.92
770-584	54-85	Cup Gasket, White Plastic	5.59
800-241	20-2776	Intake Seat & O-Ring - 740i/ix, 840i/ix, 1140i/ix	51.03
800-242	9-2815	Ball	12.23
800-243	58-2761	Seat, Piston Valve - 740ix, 840ix, 1140ix	43.49
800-244	44-2823	Outlet Ball Cage	16.03
800-245	8-2801	Washer	1.22
800-246	57-2820	Rod - Epic 840i, 840ix, Epic 1140i, 1140ix	236.15
800-247	9-2802	Ball	15.19
800-248	49-2847	Upper Packing Assembly & Tool	51.42
800-250	49-2848	Lower Packing Assembly & Tool	74.59
800-273	20-2849	Kit - 840ix, 1140ix	89.28
800-327	8-2846	Spacer	11.31
800-332	0-2838	O-Ring	11.09
800-333	6-2844	Backup Ring	2.58
800-336	44-2803	Retainer, Outlet Valve	35.60
800-348	8-2804	Upper Seal, Outlet Valve	2.07
800-353	—	Order as: 800-248 (49-2847)	—
800-354	8-2845	Wear Ring	17.54
800-355	—	Order as: 800-250 (49-2848)	—
800-359	21-2840	Packing Installation Tool	10.67
800-365A	57-2826	Rod Assembly - Epic 840i/ix, Epic 1140i/ix	304.86
800-441	44-2805	Outlet Ball Cage	19.21
800-450	20-2810	Kit - Epic 740i, 740ix, PowrLiner 2800M	77.42
800-451	—	Replaced by 705-120A (57-2780)	—
800-452	57-2800	Rod - 740i, 740ix, PowrLiner 2800M	187.62
800-452	—	Replaced by 705-120A (57-2780)	—
800-454	49-2817	Upper Packing Assembly	58.40
800-456	49-2818	Lower Packing Assembly	76.41
800-906	15-2744	Teflon O-Ring	7.54
800-915	29-2835	Bypass Valve Assembly	75.95
800-923	20-2816	Seal Kit, Transducer	7.72
800-925	—	Order as: 700-258 (29-2600)	—
801-054	8-655	Nylon Washer	1.29
806-091	10-2715	Spacer, Backup Washer	11.05
850-004	10-1208	Gasket	24.55
850-016	0-1194	O-Ring	17.10
850-050	20-1219	Air Motor Kit - Admiral, Cmndr 40, Alaskan	118.29
858-811	19-2447	Locknut	2.74
858-812	19-1217	Nut	1.13

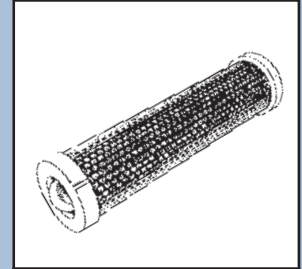

PART NO. 14-2344	5M
REPLACES 930-005	
PART NO. 14-2346	50M
REPLACES 930-006	
PART NO. 14-2347	100M
REPLACES 930-007	

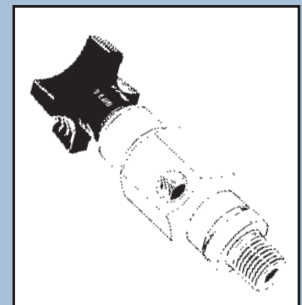

PART NO. 29-2580
REPLACES 944-620

TITAN / SPEEFLO LIST PRICES ARE BASED ON SINGLE UNIT PRICE IN TITAN / SPEEFLO U.S. PRICE LIST DATED 3/1/11

To order, contact your local
Paint Spray Equipment Dealer and ask for
Genuine Bedford Replacement Parts.

BEDFORD® Replacement Parts For . . . TITAN / SPEEFLO Equipment



PART NO. 20-2209
REPLACES 702-140

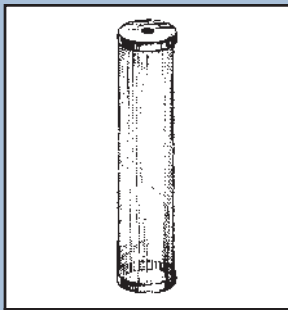

PART NO. 14-2097
REPLACES 730-067



PART NO. 14-2101
REPLACES 761-043

REPLACES TITAN PART NO.	BEDFORD PART NO.	DESCRIPTION	TITAN LIST PRICE (\$)
872-005	8-1657	Gasket	2.09
891-193	15-2589	Teflon O-Ring	3.87
891-403	15-2394	Teflon O-Ring	14.77
892-281	0-2382	O-Ring	3.22
892-323	15-2395	Teflon O-Ring	15.90
911-025	55-874	Needle Valve Packing Set	26.49
911-125	55-1220	Needle Valve Packing Set	7.72
911-225	6-873	Packing Ring	6.97
916-007	—	Replaced by 569-021 (9-654)	—
920-004	14-2265	Outlet Filter - 50 Mesh	20.96
920-005	14-2266	Outlet Filter - 100 Mesh	20.96
920-006	6-2063	Gasket, Outlet Filter (Thick)	8.62
920-050	20-2449	Filter Service Kit - 920 Series Filter	30.84
920-070	6-2064	Gasket, Outlet Filter (Thin)	8.13
920-103	9-479	Ball	13.23
920-113	—	Replaced by 920-103 (9-479)	—
930-005	14-2344	Outlet Filter Element with Ball - 5 Mesh	30.84
930-006	14-2346	Outlet Filter Element with Ball - 50 Mesh	30.84
930-007	14-2347	Outlet Filter Element with Ball - 100 Mesh	30.84
930-020	23-2588	Spring	4.67
930-050	20-2586	Service Kit - 930 Series Outlet Manifold Filter	30.84
944-000	20-2855	Kit - 944-030 Bleed Valve (Seals & Ball)	25.55
944-004	15-2522	Teflon O-Ring	3.22
944-023	44-2578	Stem, Dump Valve	—
944-026	44-2579	Stem Stop, Dump Valve	14.14
944-028	—	Replaced by 944-620 (29-2580)	—
944-038	0-2850	O-Ring	1.19
944-042	0-2852	O-Ring	1.19
944-043	58-2853	Seat, Carbide	42.19
944-044	8-2854	Seal	2.14
944-050	20-2520	Valve Service Kit - 944-620 Bleed Valve	36.23
944-620	29-2580	Outlet Bleed Valve, 1/4" NPT(m) x 1/8" NPT(f)	165.12
944-904	58-2582	Valve Seat, 1/4" NPT(m)	73.39
945-003	10-2523	Gasket	2.57

TITAN / SPEEFLO LIST PRICES ARE BASED ON SINGLE UNIT PRICE IN TITAN / SPEEFLO U.S. PRICE LIST DATED 3/1/11

BEDFORD® Replacement Parts For . . . KREMLIN Equipment

To order, contact your local
Paint Spray Equipment Dealer and ask for
Genuine Bedford Replacement Parts.

REPLACES KREMLIN PART NO.	BEDFORD PART NO.	DESCRIPTION	KREMLIN LIST PRICE (\$)
102-201-914	55-2505	Retaining Rings (10-pack)	24.15
102-202-101	55-2506	Retaining Rings (10-pack)	5.30
109-130-311	55-2933	O-Rings (10-Pack)	15.85
129-029-903	55-2507	Seals (10-pack)	32.05
129-529-903	55-2518	Teflon O-Rings (10-pack)	33.55
129-529-918	55-2509	Teflon O-Rings (10-pack)	54.65
129-609-902	55-2510	Seals (10-pack)	95.70
129-629-914	55-2512	Teflon O-Rings (10-pack)	48.20
129-659-901	20-2504	Gun Repair Kit - MX & MRX Spray Guns	42.10
129-739-910	55-2514	Valve Heads (10-pack)	34.85
129-971-002	55-2515	O-Rings (10-pack)	16.25
144-579-923	55-2516	O-Rings (10-pack)	30.10
144-850-150	20-2491	O-Ring Repair Kit - 350 Air Motor	65.40
150-040-309	55-2517	Teflon O-Rings (10-pack)	29.50
668-300-035	55-2519	Teflon O-Rings (100-pack) Ref 129.529.903	—
668-300-043	55-2511	Teflon O-Rings (100-pack) Ref 129.629.914	—
668-300-044	55-2513	Valves Heads (5 x 10-pack) Ref 129.739.910	—
909-130-438	0-2489	O-Ring	5.65
909-420-108	0-2490	O-Ring	13.70
909-420-220	0-2486	O-Ring	14.50
909-420-259	0-2488	O-Ring	13.15

KREMLIN LIST PRICES ARE BASED ON SINGLE UNIT PRICE IN KREMLIN U.S. PRICE LIST DATED 1/1/11

BEDFORD® Replacement Parts For . . . LARIUS Equipment

To order, contact your local
Paint Spray Equipment Dealer and ask for
Genuine Bedford Replacement Parts.

REPLACES LARIUS PART NO.	BEDFORD PART NO.	DESCRIPTION	LARIUS LIST PRICE (\$)
11003	8-812	Tip Sealing Washer	—
11016	10-772	Washer	—
11017	23-771	Spring	—
11019	14-834	Gun Filter, 180 Mesh, Red	—
11020	8-808	Washer	—
11037	14-833	Gun Filter, 100 Mesh, Yellow	—
11038	14-832	Gun Filter, 50 Mesh, White	—
11202	58-1495	Diffuser	—
11203	—	Replaced by Wagner 149700 (58-2305)	—
11204	58-1493	Ball Holder	—
11205	—	Replaced by Wagner 149700 (58-2305)	—
11205A	2-594	Teflon Seal	—
11209	19-1598	Locknut	—
95011-X1	1-2002	Leather V-Packing	—



To order, contact your local
Paint Spray Equipment Dealer and ask for
Genuine Bedford Replacement Parts.

BEDFORD® Replacement Parts For . . . GLIDDEN Equipment

Quick Reference for . . . GLIDDEN Pumps Private Labeled by AMSPRAY

PUMP MODEL	COMPONENT DESCRIPTION	REPLACES AMSPRAY PART NO.	BEDFORD PART NO.
500 (Non-Sleeved Fluid Sections)	Repair Kit	4235	20-1783
	Rod	191	57-1391
	Cylinder	299	57-1431
	Piston Valve	186	58-1737
	Intake Valve	205	58-1709
500 (Sleeved Fluid Sections)	Repair Kit	4235	20-1783
	Rod	181	57-1950
	Sleeve	289	57-1901
	Piston Valve	186	58-1737
750 (Non-Sleeved Fluid Sections)	Repair Kit	4235	20-1783
	Rod	19206	57-1514
	Piston Valve	186	58-1737
	Intake Valve	205	58-1709
FORMULA I	Repair Kit	4239	20-1784
SPRINT (Non-Sleeved Fluid Sections)	Repair Kit	4235	20-1783
	Rod	191	57-1391
	Cylinder	299	57-1431
	Piston Valve	186	58-1737
	Intake Valve	205	58-1709
SPRINT (Sleeved Fluid Sections)	Repair Kit	4235	20-1783
	Rod	181	57-1950
	Sleeve	289	57-1901
	Piston Valve	186	58-1737

FOR OTHER AMSPRAY REPLACEMENT REPAIR PARTS,
REFER TO PAGES 49-55

Quick Reference for . . . GLIDDEN Pumps Private Labeled by WAGNER

PUMP MODEL	COMPONENT DESCRIPTION	REPLACES WAGNER PART NO.	BEDFORD PART NO.
400 SE	Repair Kit	294904	20-2065
500 SE	Repair Kit	294905	20-2066
750 SE	Repair Kit	279910	20-2263
1000 SE	Repair Kit	294920	20-2237

FOR OTHER WAGNER REPLACEMENT REPAIR PARTS,
REFER TO PAGES 49-55

Quick Reference for . . . GLIDDEN Pumps Private Labeled by AIRLESSCO

PUMP MODEL	COMPONENT DESCRIPTION	REPLACES AIRLESSCO PART NO.	BEDFORD PART NO.
ProSpray 402, 404, 505 & 606	Repair Kit	331-210	20-1999
ProSpray 808, 1000 & 1300	Repair Kit (Standard Kit)	187-040	20-1815
	Repair Kit (All Teflon Kit)	187-042	20-1947

FOR OTHER AIRLESSCO REPLACEMENT REPAIR PARTS,
REFER TO PAGES 5-6

BEDFORD® Replacement Parts For . . . WAGNER & AMSPRAY Equipment

To order, contact your local
Paint Spray Equipment Dealer and ask for
Genuine Bedford Replacement Parts.

Quick Reference for . . . AMSPRAY Pumps

PUMP MODEL NAME	For the Bedford Replacement Part, refer to the following Amspray component P/N's				
	REPAIR KIT	ROD	CYLINDER / SLEEVE	PISTON VALVE	INTAKE VALVE
AMSPRAY					
AVENGER (396 FLUID SECT'S)	4235	181 or 191	299 (CYL)	186	205
AVENGER (EXCEL / 296 PUMPS)	4235	181 or 191	289 (SLV)	186	13363
AVENGER (PLANOTRONIC)	13292	—	—	—	310
BLACKBIRD	4239	—	—	—	—
BLUE MAX	4235	181 or 191	299(C) / 289(S)	186	205 or 13363
CORSAIR (396 FLUID SECT'S)	4235	181 or 191	299 (CYL)	186	205
CORSAIR (EXCEL / 296 PUMPS)	4235	181 or 191	289 (SLV)	186	13363
CORSAIR (PLANOTRONIC)	13292	—	—	—	310
FORMULA I S.E.	4239	—	—	—	—
MARAUDER	4239	—	—	—	—
MODEL 4	4235	181 or 191	299(C) / 289(S)	186	205 or 13363
MODEL 6	4235	181 or 191	299(C) / 289(S)	186	205 or 13363
MODEL 800	4239	—	—	—	—
PANTHER	4239	—	—	—	—
RC 125	13200	—	—	—	—
SPC 3000 G.E.	4235	181 or 191	299(C) / 289(S)	186	205 or 13363
TIGER	4239	—	—	—	—
FULLER O'BRIEN					
CHIEF	4235	181 or 191	299(C) / 289(S)	186	205 or 13363
MODEL 800	4239	—	—	—	—
SUPER CHIEF	4239	—	—	—	—
WARRIOR	4235	181 or 191	299(C) / 289(S)	186	205 or 13363
GLIDDEN					
500	4235	181 or 191	299(C) / 289(S)	186	205 or 13363
750	4235	19206	—	186	205 or 13363
FORMULA I	4239	—	—	—	—
SPRINT	4235	181 or 191	299(C) / 289(S)	186	205 or 13363
M.A.B.					
CHEETAH	4235	181 or 191	299(C) / 289(S)	186	205 or 13363
COUGAR	4235	181 or 191	299(C) / 289(S)	186	205 or 13363
PANTHER	4239	—	—	—	—
TIGER	4239	—	—	—	—
SINCLAIR					
SPC 2000	4235	181 or 191	299(C) / 289(S)	186	205 or 13363
SPC 3000	4235	181 or 191	299(C) / 289(S)	186	205 or 13363
SPC 8000	4239	—	—	—	—

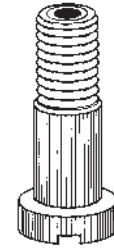

PART NO. 58-1737
REPLACES 186

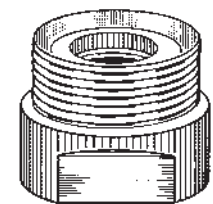

PART NO. 58-1709
REPLACES 205

To order, contact your local
Paint Spray Equipment Dealer and ask for
Genuine Bedford Replacement Parts.

BEDFORD® Replacement Parts For . . . WAGNER & AMSPRAY Equipment

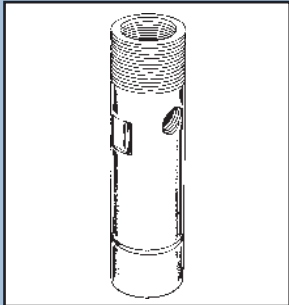

PART NO. 57-1431
REPLACES 299

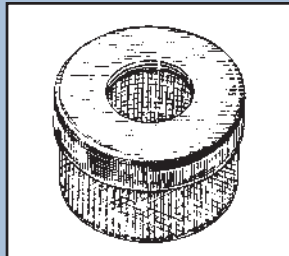

PART NO. 14-1325
REPLACES 2975 8M

PART NO. 14-1329
REPLACES 2976 16M

REPLACES WAGNER PART NO.	BEDFORD PART NO.	DESCRIPTION	WAGNER LIST PRICE (\$)
00043	18-1315	Female Adapter	5.58
00051	2-1357	Teflon V-Packing	—
00078	1-1633	Leather V-Packing	4.45
00086	18-1456	Male Adapter	5.58
00094	19-2655	Lower Packing Nut, Piston	8.78
00108	1-1634	Leather V-Packing	3.74
00116	—	Replaced by 08170 (49-1780)	—
00124	18-1538	Male Adapter	4.03
00132	18-1457	Female Gland	4.03
00159	—	Replaced by 00186 (58-1737)	—
00181	57-1950	Rod - 296 & 396 Fluid Sections	142.70
00186	58-1737	Piston Valve - 296 & 396 Fluid Sections	76.96
00191	57-1391	Rod - 396 Fluid Section	—
00203	15-1779	Teflon O-Ring	3.50
00205	58-1709	Foot Valve Assembly - 396 Fluid Section	—
00215	15-1532	Teflon O-Ring	3.50
00248	10-1671	Gasket	3.09
00264	19-1513	Ball Stop Pin	—
00289	57-1901	Sleeve - 296 (Excel) Fluid Section	136.41
00299	57-1431	Cylinder - 396 Fluid Section	—
00310	58-2778	Intake Seat - EP2100/2300, EPX2305/2355	51.03
02975	14-1325	Inlet Strainer (Coarse), 3/4" NPT Thread	11.02
02976	14-1329	Inlet Strainer (Fine), 3/4" NPT Thread	17.74
04235	20-1783	Kit - 296, 396, 19308 Fluid Sections	58.38
04239	20-1784	Kit - 9000, 9024 Fluid Sections	71.91
04243	—	Replaced by 04235 (20-1783)	—
04245	—	Replaced by 04235 (20-1783)	—
04249	—	Replaced by 04239 (20-1784)	—
04339	14-1489	Strainer - 50 Mesh	15.01
04340	14-1490	Strainer - 100 Mesh	16.85
04341	15-1474	Teflon O-Ring	4.27
05568	20-1511	Kit - 296, 396, 19308 Fluid Sections (Teflon)	—
08070	49-1778	V-Packing	4.69
08080	49-1777	V-Packing	4.51
08170	49-1780	V-Packing	—
08180	49-1781	V-Packing	3.09
09075	18-1367	Female Adapter	—
09083	—	Replaced by 08070 (49-1778)	—
09091	1-1637	Leather V-Packing	7.83
09105	18-1368	Male Adapter	—
09120	—	Replaced by 04239 (20-1784)	—
09148	18-1369	Female Adapter	12.93
09156	—	Replaced by 08080 (49-1777)	—
09164	1-1639	Leather V-Packing	7.12
09172	18-1378	Male Adapter	—
09261	10-1379	Copper Gasket	5.58
09441	15-1536	Teflon O-Ring	4.03
09446	10-1882	Washer	1.31
10775	—	Replaced by 93638 (58-1700)	—
10778	8-807	Sealing Washer	—

WAGNER LIST PRICES ARE BASED ON SINGLE UNIT PRICE IN WAGNER U.S. PRICE LIST DATED 3/1/11

BEDFORD® Replacement Parts

For . . . WAGNER & AMSPRAY Equipment

To order, contact your local
Paint Spray Equipment Dealer and ask for
Genuine Bedford Replacement Parts.

REPLACES WAGNER PART NO.	BEDFORD PART NO.	DESCRIPTION	WAGNER LIST PRICE (\$)
10779	23-769	Outlet Valve Spring	—
10780	—	Replaced by 9970102 (10-768)	—
12386	9-1862	Ball	—
13055	19-1863	Retaining Ring	—
13057	49-1868	V-Packing	—
13090	1-1864	Leather V-Packing	—
13147	15-1850	Teflon O-Ring	—
13200	20-1861	Kit - RC125	—
13204	18-1865	Female Adapter	—
13206	18-1866	Male Adapter	—
13292	20-1886	Kit - "NEW" Avenger/Corsair, 91 Fluid Section	58.80
13359	58-2791	Outlet Seat - 945, 975, EP2105, EPX2155	24.33
13361	18-1883	Female Gland	4.03
13364	19-1884	Wave Spring	7.83
13367	0-1535	O-Ring	3.50
13381	15-1885	Teflon O-Ring	3.86
13402	15-1782	Teflon O-Ring	1.54
13481	12-2766	Piston Rod Retainer	10.68
13592	—	Replaced by 13292 (20-1886)	—
13597	—	Replaced by 00203 (15-1779)	—
13862	—	Replaced by 04239 (20-1784)	—
14068	14-2596	Filter Element, Outlet Manifold, 100 Mesh	5.91
14069	14-2595	Filter Element, Outlet Manifold, 50 Mesh	5.91
14072	15-2243	Teflon O-Ring	4.33
19206	57-1514	Rod - "750" Pump	—
25014	15-1844	Teflon O-Ring	—
25029	6-1843	Backup Ring	—
34377	14-832	Gun Filter, 50 Mesh, Medium (White)	—
34383	14-834	Gun Filter, 180 Mesh, Extra-Fine (Red)	—
34511	—	Replaced by 9941501 (9-809)	—
34512	23-767	Spring	—
36462	8-588	Support, Spring	—
43052	8-812	Tip Sealing Washer	—
43209	—	Replaced by 9922703 (19-1447)	—
43211	2-594	Teflon Seal - G10 Gun	—
43215	58-1493	Ball Holder Assembly	—
43225	58-1495	Diffuser Assembly, 11/16" - G10 Gun	—
43230	—	Replaced by 149700 (58-2305)	—
43232	—	Replaced by 149700 (58-2305)	—
43234	—	Replaced by 89324 (14-833)	—
43260	10-772	Washer	—
43269	—	Replaced by 347706 (47-2450)	—
43303	8-808	Washer	—
43553	—	Replaced by 9910201 (19-1598)	—
43590	23-771	Spring	—
47485	23-1389	Spring, Outlet	—
47486	—	Replaced by 93635 (9-1049)	—
50164	9-1640	Ball	2.14
50172	9-1641	Ball	6.94
50849	19-1867	Cotter Pin	—

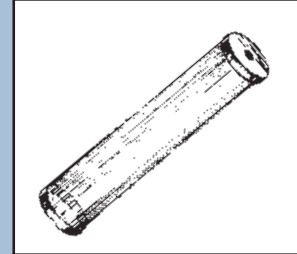

PART NO. 14-1489 50M
REPLACES 4339

PART NO. 14-1490 100M
REPLACES 4340

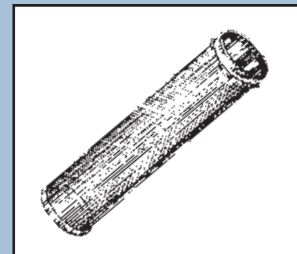

PART NO. 14-2595 50M
REPLACES 14069

PART NO. 14-2596 100M
REPLACES 14068

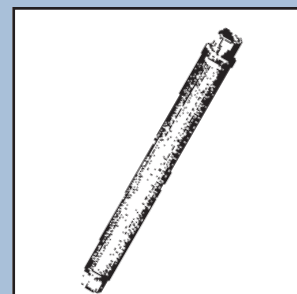

PART NO. 14-832
REPLACES 34377

WAGNER LIST PRICES ARE BASED ON SINGLE UNIT PRICE IN WAGNER U.S. PRICE LIST DATED 3/1/11

To order, contact your local
Paint Spray Equipment Dealer and ask for
Genuine Bedford Replacement Parts.

BEDFORD® Replacement Parts For . . . WAGNER & AMSPRAY Equipment

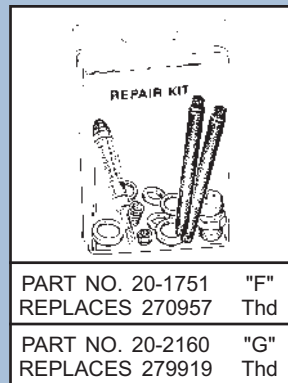
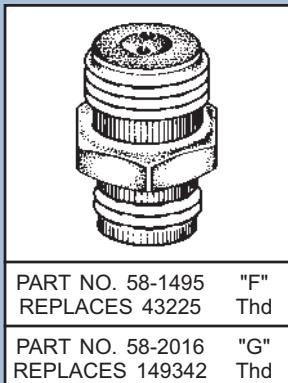
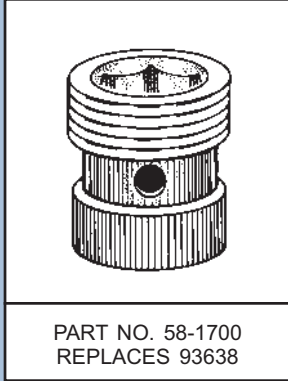

REPLACES WAGNER PART NO.	BEDFORD PART NO.	DESCRIPTION	WAGNER LIST PRICE (\$)
51055	12-1482	Plug, 1/4" NPT with Hex Socket End	1.90
51055	—	Order as: Bedford 12-1482	—
51519	9-1642	Ball	12.22
51799	9-1643	Ball	3.38
51829	19-1644	Cotter Pin	1.31
51831	19-1316	Cotter Pin	1.31
51841	19-1377	Cotter Pin	1.31
55109	—	Replaced by 154014 (13-931)	—
55412	—	Replaced by 9970103 (10-770)	—
88005	12-403	Swivel Adapter 1/4" NPT(m) x 3/8" NPS(f)	—
88161	12-404	Swivel Adapter 3/8" NPT(m) x 1/4" NPS(f)	—
88162	12-229	Nipple 1/4" NPT x 3/8" NPT	—
88241	14-856	Filter, Low Line	—
88537	20-1567	Kit - G10 Overhaul	—
88600	13-798	5' x 3/16" Airless Hose Assembly	—
89323	14-831	Gun Filter, 30 Mesh, Coarse (Green)	—
89324	14-833	Gun Filter, 100 Mesh, Fine (Yellow)	—
89494	8-2158	Seal, Outlet Seat	—
89957	55-891	Gun Filter (Kit of 2), Green, 30 Mesh	—
89958	55-892	Gun Filter (Kit of 2), White, 50 Mesh	—
89959	55-893	Gun Filter (Kit of 2), Yellow, 100 Mesh	—
89960	55-894	Gun Filter (Kit of 2), Red, 180 Mesh	—
93635	9-1049	Carbide Ball 6MM (was 47486)	—
93638	58-1700	Outlet Valve Seat (was 10775)	—
93654	0-1508	O-Ring	—
93896	12-228	Nipple 1/4" NPT x 1/4" NPT	—
0149342	58-2016	Diffuser Assembly, 7/8" - G10 to RAC IV Tip	38.63
0149700	58-2305	Needle Assembly - G10 Gun	38.63
0154014	13-931	25' x 1/4" Airless Hose Assembly (Blue)	—
0154015	13-932	50' x 1/4" Airless Hose Assembly (Blue)	—
0270491	9-2309	Ball, 5/16" Carbide	—
0270954	20-1787	Kit - Outlet Valve	70.07
0270957	20-1751	Kit - G10 Spray Gun, 11/16" Diffuser Thread	64.56
0275520	54-84	Seal, White Plastic/Foam	5.46
0276258	—	Order as: (6) pcs 275520 (54-84)	—
0279625	20-2300	Kit - G-10 Spray Gun, 7/8" Diffuser Thread	70.49
0279910	20-2263	Kit - 975, EP2400, 750SE	54.29
0279919	20-2160	Kit - G10 Spray Gun, 7/8" Diffuser Thread	64.56
0294301	23-2068	Retaining Ring	1.31
0294326	18-2067	Male Adapter	6.11
0294358	18-2169	Male Adapter	8.07
0294375	18-2069	Female Adapter, Lower	12.88
0294376	18-2070	Male Adapter, Upper	5.76
0294377	18-2071	Female Adapter, Upper	5.76
0294379	23-2072	Wave Spring, Upper	14.54
0294381	18-2073	Female Adapter, Lower	9.67
0294484	18-2074	Female Adapter, Lower	17.44
0294499	8-2592	Seal, Dump Valve	2.25
0294516	58-2593	Outlet Seat - EP 2510, EPX 2305/2405/2505	43.49
0294676	—	Replaced by 294905 (20-2066)	—

WAGNER LIST PRICES ARE BASED ON SINGLE UNIT PRICE IN WAGNER U.S. PRICE LIST DATED 3/1/11

BEDFORD® Replacement Parts

For . . . WAGNER & AMSPRAY Equipment

To order, contact your local
Paint Spray Equipment Dealer and ask for
Genuine Bedford Replacement Parts.

REPLACES WAGNER PART NO.	BEDFORD PART NO.	DESCRIPTION	WAGNER LIST PRICE (\$)
0294678	—	Replaced by 279910 (20-2263)	—
0294904	20-2065	Kit - 400SE, EP2100	51.98
0294905	20-2066	Kit - EP2300, SPC-3900, 500SE	48.36
0294914	—	Replaced by 294904 (20-2065)	—
0294920	20-2237	Kit - Glidden 1000SE	—
0294966	20-2590	Kit - Prime/Spray Valve	65.56
0295306	57-2602	Rod - EP2005, EP2105, 935, 945	88.88
0295307	46-2622	Outlet Ball Guide	—
0295308	18-2627	Upper Spacer	7.48
0295309	18-2623	Lower Spacer	11.87
0295310	49-2624	Upper Packing	14.89
0295311	49-2625	Lower Packing	22.25
0295362	18-2754	Lower Spacer	11.87
0295363	18-2753	Upper Spacer	7.48
0295366	15-2749	Teflon O-Ring	2.25
0295378	49-2751	T-Lip Packing, Upper	16.02
0295379	49-2752	T-Lip Packing, Lower	14.89
0295516	57-2604	Rod - EP2205, DSP2500, 965	94.40
0295565	14-2870	Inlet Strainer, 3/4"UNF, 16 Mesh	10.23
0295900	20-2603	Kit - EP2105	51.98
0295904	20-2750	Repair Kit - EP2205	51.98
0295915	20-2652	Kit - 935, 945	—
0295989	20-2653	Kit - EP2005	51.98
0296261	58-2735	Diffuser - G10XL, G12XL	—
0296270	47-2736	Needle Assembly - G10XL, G12XL	47.41
0296288	—	Order as: 34377 (14-832)	—
0296289	8-2929	Seal, Handle	1.84
0296294	20-2737	Kit - G10XL, G12XL	71.20
0507211	57-2836	Rod Assembly - EPX2305	254.37
0507229	57-2828	Rod Assy - EPX2405/2455, EPX2505/2555	304.86
0507272	—	Replaced by 700-601A (49-2187)	—
0507452	44-2824	Outlet Ball Cage	16.03
0507454	8-2819	Washer	1.31
0507690	—	Use: Titan 700-258 (29-2600)	—
0507732	57-2822	Rod - EPX2405/2455, EPX2505/2555	236.15
0507733	44-2825	Retainer, Outlet Valve	35.60
0507734	8-2821	Seal, Outlet Seat	1.36
0507736	19-2611	Dowel Pin, 1/8" x 3/8", Cam Base	1.24
0507741	0-2105	O-Ring	—
0507742	12-2617	Retainer, Drain Valve	3.50
0507743	58-2608	Stem Assembly, Drain Valve	19.16
0507745	10-2109	Bypass Gasket	1.31
0507928	57-2742	Rod - EPX2305	195.56
0507945	44-2827	Outlet Ball Cage	9.49
0508315	15-2626	Teflon O-Ring	.83
0508451	14-2866	Outlet Filter, 30 Mesh	5.64
0508452	14-2868	Outlet Filter, 100 Mesh	5.64
0508604	15-2860	Teflon O-Ring	5.33
0508665	8-2767	Piston Guide	—
0508739	8-2769	Nylon Washer	—

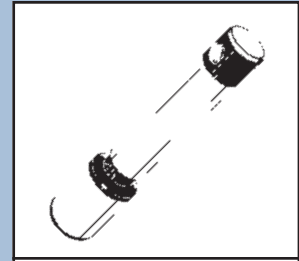

PART NO. 57-2602
REPLACES 295306

PART NO. 57-2604
REPLACES 295516

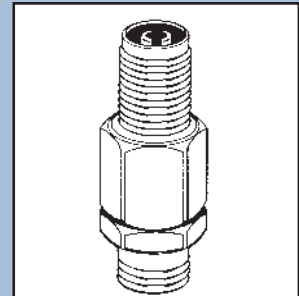

PART NO. 47-2450
REPLACES 347706

WAGNER LIST PRICES ARE BASED ON SINGLE UNIT PRICE IN WAGNER U.S. PRICE LIST DATED 3/1/11

To order, contact your local
Paint Spray Equipment Dealer and ask for
Genuine Bedford Replacement Parts.

BEDFORD® Replacement Parts For . . . WAGNER & AMSPRAY Equipment

REPLACES WAGNER PART NO.	BEDFORD PART NO.	DESCRIPTION	WAGNER LIST PRICE (\$)
0508748	14-2747	Outlet Filter, 60 Mesh	5.64
0508967	20-2833	Kit - G-15XL Spray Gun	87.94
0509581	8-2792	Seal, Foot Valve	3.32
0509582	15-2764	Teflon O-Ring	4.39
0509583	9-2763	Ball	9.91
0509584	8-2793	Upper Guide	5.04
0509762	14-2748	Inlet Strainer, for 1-1/4" Suction Tube	30.50
0516731	—	Order as: Wagner 89960 (Bedford 55-894)	—
0516732	—	Order as: Wagner 89959 (Bedford 55-893)	—
0516733	—	Order as: Wagner 89958 (Bedford 55-892)	—
0516734	—	Order as: Wagner 89957 (Bedford 55-891)	—
0551533	20-2798	Kit - EPX2155, EPX2255, SW419	56.10
0551535	10-2768	Spacer	11.87
0551536	57-2770	Piston Rod Assy - EPX2155/2255, SW419	118.07
0551537	57-2790	Piston Rod - EPX2155/2255, SW419	—
0551538	49-2782	Upper Packing Assembly with Tool	23.54
0551539	49-2789	Lower Packing Assembly	22.49
0551669	57-2830	Rod - EPX2355	187.49
0551678	57-2832	Rod Assembly - EPX2355	213.60
0347706A	47-2450	Gun Swivel - G-10	41.36
5000529	6-2106	Teflon Backup Ring	1.19
5006536	14-2682	Inlet Strainer, 1-5/16" Thread	14.41
0515220A	—	Order as: 89324 (14-833)	—
0515252A	—	Order as: 34377 (14-832)	—
9841502	9-2591	Ball, 10mm, Carbide	15.19
9871045	0-2565	O-Ring	1.01
9871046	0-2577	O-Ring	1.25
9871105	0-2765	O-Ring	2.25
9894231	23-2236	Wave Spring	12.88
9910201	19-1598	Nut	.24
9922703	19-1447	Retaining Ring (was 43209)	.42
9941501	9-809	Carbide Ball 11MM (was 34511)	20.35
9941504	—	Replaced by 93635 (9-1049)	—
9941518	9-2651	Ball, 11mm Stainless Steel	10.80
9970102	10-768	Sealing Washer (was 10780)	2.43
9970103	10-770	Washer (was 55412)	1.66

WAGNER LIST PRICES ARE BASED ON SINGLE UNIT PRICE IN WAGNER U.S. PRICE LIST DATED 3/1/11

BEDFORD® Replacement Parts

PAINT STRAINERS

To order, contact your local Paint Spray Equipment Dealer and ask for Genuine Bedford Replacement Parts.

- 60 Mesh fabric
- Specially woven for straining
- Resistant to paint solvents
- Stops spray gun clogging

2 Sizes...

SIZE	PACKED 12 / POLY BAG
	BEDFORD PART NO.
1 GALLON	14-516
5 GALLON	14-517



BEDFORD® Replacement Parts

DISPOSABLE PROTECTIVE CLOTHING

To order, contact your local Paint Spray Equipment Dealer and ask for Genuine Bedford Replacement Parts.

	FABRIC STRETCH SOCK		
	ONE SIZE FITS ALL INDIVIDUALLY PACKED	SIZE	PART NO.
		ONE SIZE FITS ALL	41-1497

	TYVEK® HOODS		
	ONE SIZE FITS ALL PACKED 12 / POLY BAG	SIZE	PART NO.
		ONE SIZE FITS ALL	41-898

	TYVEK® SHIRTS		
	SNAP CLOSURE TWO SIZES INDIVIDUALLY PACKED	SIZE	PART NO.
		LARGE	41-1271
		X-LARGE	41-1272

	TYVEK® PANTS		
	ELASTIC WAIST TWO SIZES INDIVIDUALLY PACKED	SIZE	PART NO.
		LARGE	41-1273
		X-LARGE	41-1274

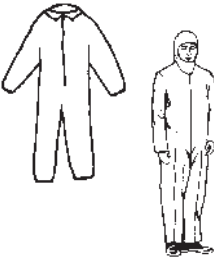
	TYVEK® COVERALLS			
	ZIPPER FRONT CLOSURE THREE SIZES INDIVIDUALLY PACKED HOODED AVAILABLE	HOODED	SIZE	PART NO.
		NO	LARGE	41-901
		NO	X-LARGE	41-964
		NO	XX-LARGE	41-928
		YES	LARGE	41-2921
		YES	X-LARGE	41-2922
		YES	XX-LARGE	41-2923

To order, contact your local
Paint Spray Equipment Dealer and ask for
Genuine Bedford Replacement Parts.

BEDFORD® Replacement Parts TANK & CUP LID GASKETS

Manufactured from the highest quality Thiokol, Stratoprene, Rubber, Leather and Plastic compounds combining the best possible solvent resisting and elastic properties for maximum seal and long life. Thiokol gaskets provide maximum solvent resistance. More economical Stratoprene gaskets provide moderate solvent resistance and are excellent when used with water based materials.

TANK-LID GASKETS



O.E.M.	SIZE	REPLACES O.E.M. PART NO.	MATERIAL	BEDFORD PART NO.
BINKS	2 Gallon	83-1419-T	Thiokol	56-19
		83-1419	Stratoprene	56-90
	5 Gallon	83-1420	Stratoprene	56-91
	10, 15 Gallon	83-1421	Stratoprene	56-92
DEVILBISS	2-1/2 Gallon	PT-33-1	Stratoprene	56-97
	5, 15 Gallon	QM-1458-1	Stratoprene	56-98
	2 Gallon	QM-1462	Stratoprene	56-93
	2 Gallon	QMS-67	Stratoprene	56-94
	2-1/2 Gallon	QMS-80-1	Stratoprene	56-95
	2 Gallon	QN-96	Rubber	56-96

CUP-LID GASKETS

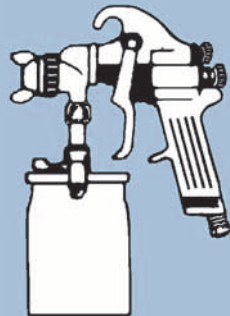

REPLACES		DESCRIPTION	BEDFORD PART NO.
O.E.M.	PART NO.		
BINKS	55-30	8 Ounce Siphon Cup, Leather	54-29
	56-730	Model 35 Gun, Thiokol	54-32
	80-11	1 & 2 Qt Pressure Cup, White Plastic	54-81
	80-45	1 & 2 Quart Pressure Cup, Leather	54-45
	82-56	1 Quart Siphon Cup, White Plastic	54-55
	82-467	1 Quart Siphon Cup, Leather	54-7
DEVILBISS	C-39-K5	White Plastic (5-pack)	55-71
	GC-25-K5	White Plastic (5-pack)	55-76
	KR-11-K5	White Plastic (5-pack)	55-74
	KR-69-K5	Leather (5-pack)	55-72
	TGC-9-K5	White Plastic (5-pack)	55-87
GRACO	M70628	2 Quart Cup, White Plastic	54-25
TITAN	770-584	White Plastic	54-85
WAGNER	275520	White Plastic	54-84

BEDFORD® Replacement Parts

HIGH PRESSURE VALVES

To order, contact your local Paint Spray Equipment Dealer and ask for Genuine Bedford Replacement Parts.

HIGH PRESSURE BALL VALVES

5000 PSI MAXIMUM WORKING PRESSURE

REPLACES GRACO PART NO.	BEDFORD PART NO.	DESCRIPTION Inlet x Outlet (under handle)
210-657	29-1440	1/4" NPT(m) x 1/4" NPT(m) with Viton Seals
210-658	29-1441	3/8" NPT(m) x 3/8" NPT(m) with Viton Seals
210-659	29-1442	3/8" NPT(m) x 1/4" NPT(m) with Viton Seals
214-037	29-1443	1/4" NPT(m) x 1/4" NPT(m) with Teflon Seals
223-959	29-1791	3/8" NPT(m) x 1/4" NPT(m) with Teflon Seals
223-960	29-1504	3/8" NPT(m) x 3/8" NPT(m) with Teflon Seals
217-559	20-1259	Ball Valve Repair Kit - Viton Contains: Valve Ball, Seats & Viton Seals
217-560	20-1260	Ball Valve Repair Kit - Teflon Contains: Valve Ball, Seats & Teflon Seals

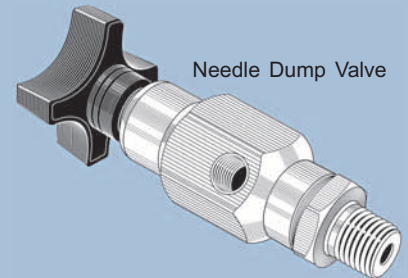
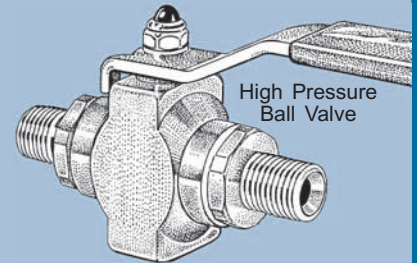

NEEDLE DUMP VALVE

5000 PSI MAXIMUM WORKING PRESSURE

REPLACES SPEEFLO PART NO.	BEDFORD PART NO.	DESCRIPTION
944-620	29-2580	1/4" NPT(m) Inlet x 1/8" NPT(f) Outlet

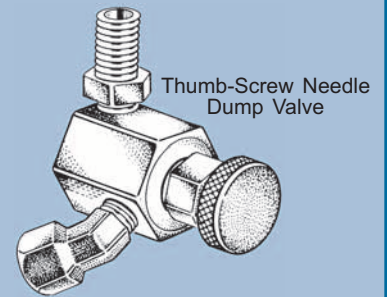

THUMB-SCREW NEEDLE DUMP VALVES

5000 PSI MAXIMUM WORKING PRESSURE

REPLACES GRACO PART NO.	BEDFORD PART NO.	DESCRIPTION
222-198	29-1974	1/4" NPT(m) Inlet Connection
224-775	29-2630	1/8" NPT(f) Inlet x 1/8" NPT(f) Outlet, Bare Valve
235-198	20-2078	Dump Valve Repair Kit - Contains: Stem Assembly, Ball, Carbide Seat, Gasket

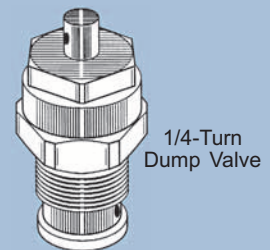

1/4-TURN DUMP VALVE

3000 PSI MAXIMUM WORKING PRESSURE

REPLACES GRACO PART NO.	BEDFORD PART NO.	DESCRIPTION
235-014	20-2324	Valve Body Assembly, Carbide Ball Seat, & Gasket
239-914	20-2806	Valve Body Assembly w/ Solvent Resistant O-Ring

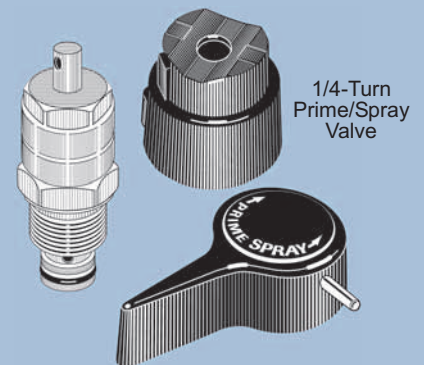

1/4-TURN PRIME/SPRAY VALVE

3000 PSI MAXIMUM WORKING PRESSURE

REPLACES TITAN PART NO.	BEDFORD PART NO.	DESCRIPTION
700-258	29-2600	Valve Body Assembly, Handle Base, Pin
800-915	29-2835	Valve Body Assembly w/ Solvent Resistant O-Ring

To order, contact your local Paint Spray Equipment Dealer and ask for Genuine Bedford Replacement Parts.

BEDFORD® Replacement Parts LOW PRESSURE VALVES

LOW PRESSURE BALL VALVES

250 PSI MAXIMUM WORKING PRESSURE

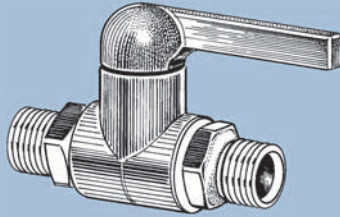

Low Pressure Ball Valve

REPLACES BINKS PART NO.	BEDFORD PART NO.	FITTING CONFIGURATION Outlet (under handle) x Inlet
72-81611	29-1570	1/4" NPS(m) x 1/4" NPT(m)
72-81712	29-1571	3/8" NPS(m) x 3/8" NPT(m)
72-81612	29-1672	1/4" NPS(m) x 3/8" NPT(m)
72-81216	29-1693	3/8" NPT(m) x 1/4" NPS(m)
72-81711	29-1694	3/8" NPS(m) x 1/4" NPT(m)
72-81212	29-2375	3/8" NPT(m) x 3/8" NPT(m)
72-83030	29-2575	1/4" NPT(m) x 1/4" NPT(m)
72-84030	29-2601	3/8" NPT(m) x 1/4" NPT(m)
72-84040	29-2576	3/8" NPT(m) x 3/8" NPT(m)
83-2600	6-982	Replacement Teflon Seal (2 required per valve)

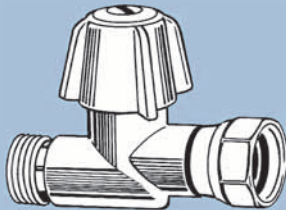

Air Metering "Cheater" Valve

AIR METERING "CHEATER" VALVE

125 PSI MAXIMUM WORKING PRESSURE

REPLACES BINKS PART NO.	BEDFORD PART NO.	DESCRIPTION
73-157	29-1680	1/4" NPS(m) x 1/4" NPS(f)

To order, contact your local Paint Spray Equipment Dealer and ask for Genuine Bedford Replacement Parts.

BEDFORD® Replacement Parts QUART SIPHON CUP ASSEMBLIES

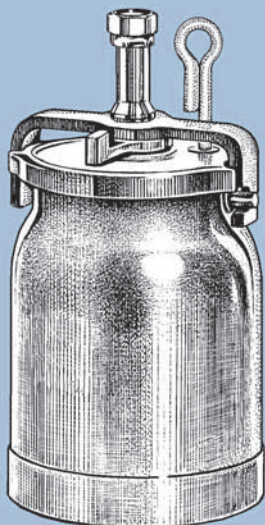

Non-Drip Quart Siphon Cup Assembly

BEDFORD Quart Siphon Cup Assembly comes complete with sturdy aluminum cup and 3/8" NPS female swivel nut connection that fits most guns.

Available in Standard and Non-Drip models with exclusive directional vent tube.

Individually boxed.

REPLACES BINKS PART NO.	BEDFORD PART NO.	DESCRIPTION
81-550	45-1255	Standard Unit (Complete Assembly)
81-350	45-1235	Non-Drip Unit (Complete Assembly)
82-47	45-899	Quart Cup (Fits both units)
82-467	54-7	Gasket, Leather (as supplied with units)
82-56	54-55	Gasket, White Foam
—	13-250	Vent Tube Assembly

BEDFORD® Replacement Parts

LOW PRESSURE BULK HOSE

To order, contact your local
Paint Spray Equipment Dealer and ask for
Genuine Bedford Replacement Parts.

LOW PRESSURE BULK HOSE

AIR HOSE

- Red Cover
- Full Reels: 600'-750'
- Maximum Working Pressure: 250 PSI
- Maximum 3 Pieces per Reel (Random Lengths)

DIMENSIONS		NO. BRAIDS	TUBE	COVER	REPLACES PART NO.			BEDFORD FULL REEL	BEDFORD CUT LENGTH
I.D.	O.D.				BINKS	DEVILBISS	GRACO	PART NO.	PART NO.
1/4"	1/2"	1	Buna-N	Smooth	71-10000	H1957-1	061-204	13-4	13-64
5/16"	5/8"	1	Buna-N	Corrugated	—	H1901-1	—	13-57	13-77
5/16"	5/8"	1	Buna-N	Smooth	71-11000	H1921-1	061-207	13-59	13-79
3/8"	11/16"	1	Buna-N	Smooth	71-12000	H1958-1	061-089	13-6	13-66



FLUID HOSE

- Black Neoprene Cover
- Full Reels: 600'-750'
- Maximum Working Pressure: 750 PSI
- Nylon Inner Tube
- Maximum 3 Pieces per Reel (Random Lengths)
- Temperature Range: -40°F to +190°F

DIMENSIONS		NO. BRAIDS	TUBE	COVER	REPLACES PART NO.			BEDFORD FULL REEL	BEDFORD CUT LENGTH
I.D.	O.D.				BINKS	DEVILBISS	GRACO	PART NO.	PART NO.
1/4"	1/2"	1	Nylon	Neoprene	71-280	H1975-1	061-205	13-470	13-1170
3/8"	11/16"	1	Nylon	Neoprene	71-282	H1973-1	061-195	13-480	13-1180
1/2"	7/8"	2	Nylon	Neoprene	71-283	H1974-1	061-200	13-1010	13-1110
3/4"	1-3/16"	2	Nylon	Neoprene	71-284	—	061-185	13-490	13-1190
1"	1-1/2"	2	Nylon	Neoprene	71-285	—	061-188	13-2550	—

LOW PRESSURE REUSABLE HOSE CONNECTIONS

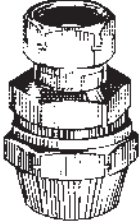
- Plated Brass
- 30° Seat

	BEDFORD PART NO.	REPLACEMENT FOR:			HOSE SIZE ID x OD	THREAD
		BINKS PART NO.	DEVILBISS PART NO.	GRACO PART NO.		
	12-304	72-1303	P-HC-4523	104-415	1/4" x 1/2"	1/4" NPS(F) Swivel
	12-306	72-1306	P-HC-4543	104-084	1/4" x 1/2"	3/8" NPS(F) Swivel
	12-301	72-1317	P-HC-4527	103-605	5/16" x 5/8"	1/4" NPS(F) Swivel
	12-305	72-1478	P-HC-4599	—	5/16" x 5/8"	1/4" NPT(M)
	12-302	72-1328	P-HC-4548	104-414	3/8" x 11/16"	3/8" NPS(F) Swivel
	12-303	72-1325	P-HC-4528	—	3/8" x 11/16"	1/4" NPS(F) Swivel
	12-368	72-1333	P-HC-4551	101-201	1/2" x 7/8"	3/8" NPS(F) Swivel
		BEDFORD PART NO.	REPLACEMENT FOR:		COMPRESSION RING FOR CONNECTOR PART NO.	
BINKS PART NO.			GRACO PART NO.			
12-310		72-854	104-412	12-304, 12-306		
12-311		72-855	—	12-301, 12-305		
12-312		72-856	104-413	12-302, 12-303		
12-313	—	—	12-368			

To order, contact your local
Paint Spray Equipment Dealer and ask for
Genuine Bedford Replacement Parts.

BEDFORD® Replacement Parts HOSE ASSEMBLIES

LOW PRESSURE AIR & FLUID HOSE ASSEMBLIES

BULK HOSE NO.	HOSE I.D.	FITTING - THREAD	ASSEMBLY LENGTH				
			15'	25'	50'	75'	100'
			P/N	P/N	P/N	P/N	P/N
AIR HOSE ASSEMBLIES							
13-4	1/4	12-304 - 1/4 NPS(F)	13-520	13-521	13-522	13-523	13-524
13-57	5/16 C	12-301 - 1/4 NPS(F)	13-362	13-358	13-359	13-360	13-361
13-59	5/16 S	12-301 - 1/4 NPS(F)	13-366	13-354	13-355	13-356	13-357
13-6	3/8	12-302 - 3/8 NPS(F)	13-529	13-525	13-526	13-527	13-528
FLUID HOSE ASSEMBLIES							
13-470	1/4	12-306 - 3/8 NPS(F)	13-475	13-471	13-472	13-473	13-474
13-480	3/8	12-302 - 3/8 NPS(F)	13-485	13-481	13-482	13-483	13-484
13-1010	1/2	12-368 - 3/8 NPS(F)	13-1015	13-1011	13-1012	13-1013	13-1014
13-490	3/4	*12-429 - 3/4 NPT(M)	13-498	13-494	13-495	13-496	13-497

* Permanent factory-installed fittings

SUCTION HOSE ASSEMBLIES

HOSE I.D.	LENGTH	BEDFORD PART NO.	CONNECTOR THREAD INSTALLED
3/4"	3'	13-499	Hose Only (no fittings)
3/4"	3-1/2'	13-491	3/4" NPT(m) x 3/4" NPT(m)
3/4"	6'	13-492	3/4" NPT(m) x 3/4" NPT(m)
1"	4'	13-2557	Hose Only (no fittings)
1"	5'	13-2558	Hose Only (no fittings)
1"	6'	13-2556	1" NPT(m) Rigid x 1" NPT(m) Swivel

PRESSURE WASHER HOSE ASSEMBLIES

- Non-Marking Cover
- Heavy Duty Bend Restrictors
- Rated for Intermittent Use up to 250°F.
- 3/8" ID Rubber Tube / Wire Braided

3/8" PRESSURE WASHER HOSE ASSEMBLIES

LENGTH	PRESSURE RATING (PSI)	BEDFORD PART NO.	CONNECTIONS / FITTINGS
50'	4000	13-2542	3/8" NPT(m) Rigid x 3/8" NPT(m) Swivel
50'	4000	13-2543	With Quick Disconnect Coupler & Plug Installed

PRESSURE WASHER QUICK DISCONNECT FITTINGS

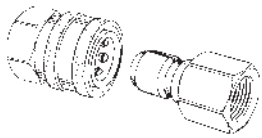
	BEDFORD PART NO.	DESCRIPTION
	12-2524	Plug - 3/8" NPT(f), Stainless Steel
	12-2525	Plug - 3/8" NPT(f), Plated Steel
	12-2526	Coupler - 3/8" NPT(f), Brass
	12-2527	Coupler - 3/8" NPT(f), Stainless Steel

AIRLESS HOSE ASSEMBLIES

Airless hose assemblies are conductive for static grounding and are 100% inspected for conductivity. Synthetic braid gives hose accumulator effect to prevent damage to pumps. Hose has a blue abrasion resistant polyurethane cover and a nylon tube. Temperature range: 0°F to +180°F.

3/16" AIRLESS HOSE ASSEMBLIES
3,500 PSI WORKING PRESSURE

Supplied with fittings as shown, and spring guards on both ends.

LENGTH	BEDFORD PART NO.	FITTINGS INSTALLED	REPLACEMENT FOR:		
			GRACO PART NO.	BINKS PART NO.	WAGNER PART NO.
2'	13-791	1/4"(M) x 1/4"(F)	214-700	—	—
3'	13-792	1/4"(M) x 1/4"(F)	214-701 / 238-358	—	—
5'	13-798	1/4"(M) x 1/4"(F)	—	71-8085	88600
6'	13-793	1/4"(M) x 1/4"(F)	214-699 / 238-359	—	—
10'	13-794	1/4"(M) x 1/4"(F)	—	71-8086	—
15'	13-795	1/4"(F) x 1/4"(F)	214-981	71-8087	—
25'	13-796	1/4"(F) x 1/4"(F)	214-698	71-8088	153000
50'	13-797	1/4"(F) x 1/4"(F)	214-697	71-8089	153001

1/4" AIRLESS HOSE ASSEMBLIES
3,300 PSI WORKING PRESSURE

Supplied with 1/4" NPS female fittings, and spring guards on both ends.

LENGTH	BEDFORD PART NO.	REPLACEMENT FOR:		
		GRACO PART NO.	BINKS PART NO.	WAGNER PART NO.
2-1/2'	13-1855	223-766	—	—
25'	13-931	223-540 / 240-793	71-7704	154014
50'	13-932	223-541 / 240-794	71-7705	154015

3/8" AIRLESS HOSE ASSEMBLIES
3,300 PSI WORKING PRESSURE

Supplied with 3/8" NPT female fittings and spring guards on both ends.

LENGTH	BEDFORD PART NO.	REPLACEMENT FOR:			
		GRACO PART NO.	BINKS PART NO.	SPEEFLO PART NO.	WAGNER PART NO.
25'	13-451	214-703 / 240-796	71-8424	225-038	88003
50'	13-453	214-705 / 240-797	71-8425	250-038	88004

To order, contact your local
Paint Spray Equipment Dealer and ask for
Genuine Bedford Replacement Parts.

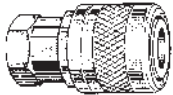
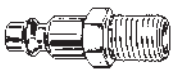

BEDFORD® Replacement Parts FITTINGS & ADAPTERS

QUICK DISCONNECTS - Automatic Type - 250 PSI - For Air and Water

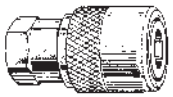
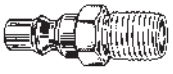

1330 SERIES	BEDFORD PART NO.	THREAD	INTERCHANGES WITH:				
			GRACO NO.	PARKER NO.	MILTON NO.	ALEMITE NO.	ARO NO.
	12-1330	1/4" NPT(f)	208-536	23 / 43	715	328030	23002-200
	12-1331	1/4" NPT(m)	—	22 / 42	716	330604	23002-212
	12-1332	1/4" NPT(f)	169-967	H3C	728	330605	23902-200
	12-1333	1/4" NPT(m)	169-970	H2C	727	328034	23902-210
	12-1334	3/8" NPT(m)	169-971	H2C-E	733	—	23902-310

1340 SERIES	BEDFORD PART NO.	THREAD	INTERCHANGES WITH:				
			GRACO NO.	PARKER NO.	MILTON NO.	ALEMITE NO.	ARO NO.
	12-1340	1/4" NPT(f)	—	53	775	—	210
	12-1341	1/4" NPT(m)	—	52	—	—	210-212
	12-1342	1/4" NPT(f)	—	A3C	778	—	2609
	12-1343	1/4" NPT(m)	—	A2C	777	—	2608

QUICK DISCONNECTS - 5000 PSI - For Pressure Washers

2520 SERIES	BEDFORD PART NO.	THREAD	INTERCHANGES WITH:	DESCRIPTION
			GRACO NO.	
	12-2526	3/8" NPT(f)	801-569	Brass Stainless Steel
	12-2527	3/8" NPT(f)	803-157	
	12-2524	3/8" NPT(f)	801-568	Stainless Steel Plated Steel
	12-2525	3/8" NPT(f)	—	

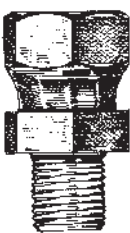
SWIVEL ADAPTER UNIONS - Plated Steel - High Pressure (5000 PSI)

	BEDFORD PART NO.	REPLACEMENT FOR:			DESCRIPTION	
		GRACO PART NO.	BINKS PART NO.	ALEMITE PART NO.	FRONT END	SWIVEL END
	12-402	156-823	41-1412	1000-44	1/4" NPT(m)	1/4" NPS(f)
	12-403	157-705	20-4468	1000-46	1/4" NPT(m)	3/8" NPS(f)
	12-404	154-986	—	1000-64	3/8" NPT(m)	1/4" NPS(f)
	12-405	155-665	20-4281	1000-66	3/8" NPT(m)	3/8" NPS(f)
	12-406	162-505	72-945	1000-68	3/8" NPT(m)	1/2" NPS(f)
	12-407	158-256	20-4067	1000-86	1/2" NPT(m)	3/8" NPS(f)
	12-465	156-684	20-4283	1000-88	1/2" NPT(m)	1/2" NPS(f)
	12-408	157-785	20-4455	—	3/4" NPT(m)	3/4" NPS(f)
	12-418	155-470	—	—	1/2" NPT(m)	1/2" NPS(f)x90°
	12-410	—	—	—	1/8" NPT(f)	1/8" NPS(f)
	12-409	155-570	83-1935	1012-44	1/4" NPT(f)	1/4" NPS(f)
	12-251	156-173	20-4256	1012-66	3/8" NPT(f)	3/8" NPS(f)
	12-411	161-077	20-4276	1012-86	1/2" NPT(f)	3/8" NPS(f)
	12-412	155-865	20-4277	1012-88	1/2" NPT(f)	1/2" NPS(f)
	12-413	156-172	20-4278	1012-1212	3/4" NPT(f)	3/4" NPS(f)
	12-201	157-676	72-918	—	1/4" NPT(f)	1/4" NPS(f)x90°
	12-431	157-416	—	—	1/2" NPT(f)	1/2" NPS(f)x90°
	12-415	156-589	—	—	3/4" NPT(f)	3/4" NPS(f)x90°

BEDFORD® Replacement Parts

FITTINGS & ADAPTERS

To order, contact your local
Paint Spray Equipment Dealer and ask for
Genuine Bedford Replacement Parts.

FULL-TIME LIVE SWIVEL CONNECTIONS - Plated Steel - 3600 PSI WPR

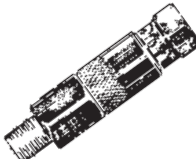
	BEDFORD PART NO.	REPLACES GRACO PART NO.	DESCRIPTION
	12-2400 12-1900	239-663 223-341	Swivel - 1/4" NPS (f) x 1/4" NPT (m) - Leather Packed Swivel - 1/4" NPS (f) x 1/4" NPT (m) - Teflon Packed

ADAPTERS - Brass - Low Pressure (750 PSI)

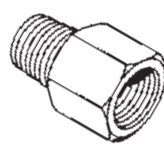
	BEDFORD PART NO.	REPLACEMENT FOR:		DESCRIPTION MALE THREAD x FEMALE THREAD
		BINKS PART NO.	DEVILBISS PART NO.	
12-599 12-1225	72-55 72-54	AD-404 P-H-4105	1/4" NPS (m) x 3/8" NPS (f) 3/8" NPS (m) x 1/4" NPS (f)	

NIPPLES - Brass - Low Pressure (750 PSI) - 30° Seat Both Ends

	BEDFORD PART NO.	REPLACEMENT FOR:		DESCRIPTION
		BINKS PART NO.	DEVILBISS PART NO.	
12-224	—	—	1/8" NPS x 1/8" NPS	
12-227	71-28	H-1766	1/8" NPT x 1/4" NPS	
12-221	83-1050	AD-31	1/4" NPS x 1/4" NPS	
12-222	83-576	H-2008	1/4" NPS x 1/4" NPT	
12-225	—	—	1/4" NPS x 3/8" NPS	
12-878	—	H-153	1/4" NPS x 5/8"-18	
12-879	—	H-77	3/8" NPS x 5/8"-18	
12-223	83-1294	H-1446	3/8" NPS x 3/8" NPS	

NIPPLES - Plated Steel - High Pressure (5000 PSI) - 30° Seat Both Ends

	BEDFORD PART NO.	REPLACEMENT FOR:			DESCRIPTION
		GRACO PART NO.	BINKS PART NO.	WAGNER PART NO.	
12-1978	151-519	—	—	1/8" NPT x 1/4" NPT	
12-228	156-971	—	93896	1/4" NPT x 1/4" NPT	
12-219	162-453	—	—	1/4" NPT x 1/4" NPS	
12-229	157-350	72-995	88162	1/4" NPT x 3/8" NPT	
12-230	156-849	—	88160	3/8" NPT x 3/8" NPT	
12-232	159-239	—	—	3/8" NPT x 1/2" NPT	
12-231	158-491	—	—	1/2" NPT x 1/2" NPT	



PLUGS - Plated Steel

	BEDFORD PART NO.	REPLACEMENT FOR:			DESCRIPTION
		GRACO PART NO.	BINKS PART NO.	DEVILBISS PART NO.	
12-1480	100-403	—	SS-1215	1/8" NPT - Square Head	
12-1481	100-509	86-558	SS-1216	1/4" NPT - Square Head	
12-1482	100-721	20-2288	—	1/4" NPT - Socket Head	
12-2138	—	—	—	1/4" NPT - Hex Head	
12-1483	100-040	20-1592	SS-1217	3/8" NPT - Square Head	

To order, contact your local
Paint Spray Equipment Dealer and ask for
Genuine Bedford Replacement Parts.

BEDFORD® Replacement Parts FILTERS & STRAINERS

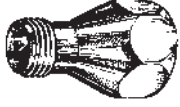
TIP FILTERS, INLINE FILTER, & ACCESSORIES

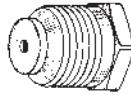



	REPLACES		BEDFORD PART NO.	DESCRIPTION
	OEM	PART NO.		
	Graco	205-264	14-151	Tip Filter, Fine, 100 Mesh
	Graco	205-265	14-152	Tip Filter, Coarse, 60 Mesh
	Binks	54-1835	14-1161	Tip Filter, Fine, 100 Mesh
	Binks	54-1836	14-1162	Tip Filter, Coarse, 60 Mesh
	Graco	164-120	12-620	Tip Filter Housing Stainless Steel, 7/8"(f) - 11/16"(m) Threads (May also be used as an adapter to convert from "G" gun thread to "F" tip base thread)
	Graco	210-500	14-1200	Inline Filter Assembly (Stainless Steel) 1/4" NPS(f) x 1/4" NPS(m) (Includes (1) Fine Tip Filter)
	Graco	181-084	12-1587	Adapter - Binks Gun to Graco Tip Base (3/4"(f) "B" Thread - 7/8"(m) "G" Thread)
	Graco	181-085	12-1486	Adapter - Wagner / Airlessco / ASM Guns to Graco Tip Base (11/16"(f) "F" Thread - 7/8"(m) "G" Thread)

Note: Replacement for Graco 212-058 - Order (1)8-122, (1)12-620, (1)14-151, (1)14-152

AIR & FLUID INLINE STRAINER ELEMENTS

	REPLACES		BEDFORD PART NO.	MESH	DESCRIPTION
	OEM	PART NO.			
	Binks	83-2705	14-1731	30	Filter Element
	Binks	83-2089	14-1732	50	Filter Element
	Binks	83-2596	14-1733	80	Filter Element
	Binks	83-1256	14-1734	100	Filter Element
	Binks	83-2405	14-1735	150	Filter Element
	Binks	83-2706	14-1736	200	Filter Element

AIRLESS GUN FILTERS



	REPLACES		BEDFORD PART NO.	MESH	DESCRIPTION
	OEM	PART NO.			
	Graco	287-032	14-2664	60	Contractor II / FTx II Gun Filter - Black
	Graco	287-033	14-2665	100	Contractor II / FTx II Gun Filter - Blue
	Graco	287-034	14-2648	60 & 100	Contractor II / FTx II Gun Filters - Twin-Pack
	Graco	218-131	14-1484	50	Contractor Gun Filter Assembly - Coarse
	Graco	218-133	14-1485	100	Contractor Gun Filter Assembly - Fine
	Graco	179-731	14-1118	50	Contractor Gun Filter Element - Coarse
	Graco	179-732	14-1120	100	Contractor Gun Filter Element - Fine
	Wagner	89323	14-831	30	G-10 Gun Filter - Coarse (Green)
	Wagner	34377	14-832	50	G-10 Gun Filter - Medium (White)
	Wagner	89324	14-833	100	G-10 Gun Filter - Fine (Yellow)
	Wagner	34383	14-834	180	G-10 Gun Filter - Extra Fine (Red)
	Titan	500-200-03	14-2171	30	LX-80 Gun Filter, 2-pack - Coarse (Green)
	Titan	500-200-06	14-2172	60	LX-80 Gun Filter, 2-pack - Medium (White)
	Titan	500-200-10	14-2173	100	LX-80 Gun Filter, 2-pack - Fine (Yellow)
	Titan	500-200-15	14-2174	150	LX-80 Gun Filter, 2-pack - Extra Fine (Red)

BEDFORD® Replacement Parts

FILTERS & STRAINERS

To order, contact your local
Paint Spray Equipment Dealer and ask for
Genuine Bedford Replacement Parts.

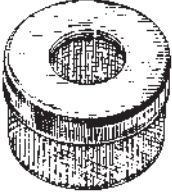
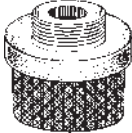
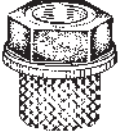
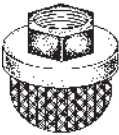
INLET STRAINERS ("Rock Catchers")

	REPLACES		BEDFORD PART NO.	MESH	SIZE / DESCRIPTION
	OEM	PART NO.			
	Stainless Steel Cap, Stainless Steel Screen				
	Airlessco	141-008	14-1817	16	3/4" NPT, Double Screen
	Amspray	2975	14-1325	8	3/4" NPT, Single Screen
	Amspray	2976	14-1329	16	3/4" NPT, Double Screen
	Binks	41-10094	14-674	16	3/4" NPT, Double Screen
	Graco	181-072	14-1223	16	1" NPT, Stainless Steel Cap, Double Screen
	Graco	181-073	14-1224	16	1/2" NPT, Stainless Steel Cap, Double Screen
	Graco	183-770	14-1428	16	3/4" NPT, Stainless Steel Cap, Double Screen
	Graco	189-920	14-2179	8	1" NPT, Single Screen
	H.E.R.O.	187A	14-2332	16	3/4" NPT, Double Screen
	Wagner	88241	14-856	10	Large Metric, Single Screen
	Nylon Cap, Stainless Steel Screen - Order by Bedford P/N:				
Graco	181-072(P)	14-2353	16	1" NPT, Nylon Cap, Double Screen	
Graco	181-073(P)	14-2351	16	1/2" NPT, Nylon Cap, Double Screen	
Graco	183-770(P)	14-2352	16	3/4" NPT, Nylon Cap, Double Screen	
	Graco	243-082	14-2530	36	3/4" Garden Hose Thread for Magnum Pumps
	Graco	235-004	14-1964	12	3/4" UNF Thread for 390st & Nova SP
	Graco	246-385	14-2649	12	7/8" UNF Thread for Ultra 395/495 Pumps
	Titan	700-805	14-2081	10	3/4" UNF Thread for all Epic Series Pumps
	Titan	710-046	14-2082	10	1-5/16" Thread for all Elite Series Pumps
	Wagner	5006536	14-2682	10	1-5/16" Thread for EPX/GPX Pumps
	Graco	207-241	14-700	60	Wire Cage & Bag for 3/4" OD Tube
	Graco	210-726	14-900	60	Wire Cage & Bag for 1-1/4" OD Tube
	Graco	207-240	14-370	60	Replacement Filter Bags (12-Pack)
	Graco	238-769	14-2170	60	Replacement Filter Bags (25-Pack)
	Speeflo	103-625	14-2297	10	Inlet Strainer Assembly for 1" OD Tube
	Speeflo	103-627	14-2299	10	Inlet Strainer Assembly for 1-1/4" OD Tube
	Wagner	509762	14-2748	10	Inlet Strainer Assembly for 1-1/4" OD Tube



INLET SUMP FILTER ELEMENTS

	REPLACES		BEDFORD PART NO.	MESH	DESCRIPTION
	OEM	PART NO.			
	Speeflo	103-628	14-904	30	Inlet Sump Filter Element
	Speeflo	103-624	14-905	50	Inlet Sump Filter Element

To order, contact your local
Paint Spray Equipment Dealer and ask for
Genuine Bedford Replacement Parts.

BEDFORD® Replacement Parts FILTERS & STRAINERS

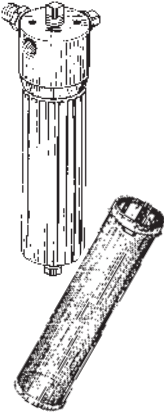
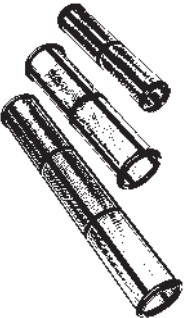
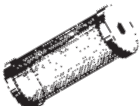
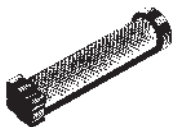
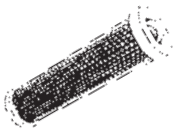
FLUID OUTLET MANIFOLD ASSEMBLY & OUTLET FILTERS

	REPLACES		BEDFORD PART NO.	MESH	DESCRIPTION
	OEM	PART NO.			
	Graco	214-570	14-1566	60	Fluid Outlet Manifold Filter - Complete Assembly
	Amspray	4339	14-1489	50	Fluid Outlet Strainer
	Amspray	4340	14-1490	100	Fluid Outlet Strainer
	Amspray	14068	14-2596	100	Fluid Outlet Strainer (solid end cap)
	Amspray	14069	14-2595	50	Fluid Outlet Strainer (solid end cap)
	Graco	167-024	14-184	30	Fluid Outlet Strainer (Long)
	Graco	167-025	14-185	60	Fluid Outlet Strainer (Long)
	Graco	167-026	14-186	100	Fluid Outlet Strainer (Long)
	Graco	167-027	14-187	200	Fluid Outlet Strainer (Long)
	Titan	730-067-30	14-2096	30	Fluid Outlet Strainer - for Epic 660ex, 690gx, Promark 690
	Titan	730-067	14-2097	60	Fluid Outlet Strainer - for Epic 660ex, 690gx, Promark 690
	Titan	730-067-10	14-2098	100	Fluid Outlet Strainer - for Epic 660ex, 690gx, Promark 690
	Titan	761-043	14-2101	60	Fluid Outlet Strainer - for all Elite Pumps
	Wagner	508748	14-2747	60	Fluid Outlet Strainer - EPX / GPX
	Graco	246-384	14-2675	60	Fluid Outlet Strainer, Short, Black
	Graco	246-382	14-2676	100	Fluid Outlet Strainer, Short, Blue
	Graco	243-080	14-2685	60	Fluid Outlet Strainer, Medium, Black
	Graco	243-081	14-2686	100	Fluid Outlet Strainer, Medium, Blue
	Graco	243-226	14-2687	200	Fluid Outlet Strainer, Medium, Red
	Graco	244-071	14-2694	30	Fluid Outlet Strainer, Long, Gray
	Graco	244-067	14-2695	60	Fluid Outlet Strainer, Long, Black
	Graco	244-068	14-2696	100	Fluid Outlet Strainer, Long, Blue
	Graco	244-069	14-2697	200	Fluid Outlet Strainer, Long, Red
	Graco	167-052	14-192	30	Fluid Outlet Strainer (Short)
	Graco	167-053	14-193	60	Fluid Outlet Strainer (Short)
	Graco	167-054	14-194	100	Fluid Outlet Strainer (Short)
	Graco	167-055	14-195	200	Fluid Outlet Strainer (Short)
	Graco	243-070	14-2650	30	Fluid Outlet Filter - for Magnum XR Pumps
	Speeflo	920-004	14-2265	50	Fluid Outlet Strainer
	Speeflo	920-005	14-2266	100	Fluid Outlet Strainer
	Speeflo	930-005	14-2344	5	Fluid Outlet Strainer with Check Ball
	Speeflo	930-006	14-2346	50	Fluid Outlet Strainer with Check Ball
	Speeflo	930-007	14-2347	100	Fluid Outlet Strainer with Check Ball
		Titan	500-200-03	14-2171	30
Titan		500-200-06	14-2172	60	Fluid Outlet Strainer, white (2-pack) - for Epic 440e, 447ex
Titan		500-200-10	14-2173	100	Fluid Outlet Strainer, yellow (2-pack) - for Epic 440e, 447ex
Titan		500-200-15	14-2174	150	Fluid Outlet Strainer, red (2-pack) - for Epic 440e, 447ex
	Binks	41-2627	14-345	100	Fluid Outlet Filter Screen (Long)
	Binks	41-2628	14-346	60	Fluid Outlet Filter Screen (Long)
	Binks	41-2629	14-347	50	Fluid Outlet Filter Screen (Long)

BEDFORD® Replacement Parts

SPRAY GUN REPAIR PARTS

To order, contact your local Paint Spray Equipment Dealer and ask for Genuine Bedford Replacement Parts.

CONVENTIONAL & HVLP SPRAY GUN REPAIR PARTS

SPRAY GUN	REPLACES OEM PART NO.	BEDFORD PART NO.	DESCRIPTION
Binks Model 7	6-188	20-324	Repair Kit
Binks Model 18	6-189	20-328	Repair Kit
Binks Model 69	6-195	20-329	Repair Kit
Binks Model 95	54-3577	20-2154	Repair Kit
Binks Model 2001	6-229	20-1175	Repair Kit
Binks MACH I / BBR	54-3605	20-1880	Repair Kit
	54-3980	20-2340	Repair Kit (For Automatic Guns)
DeVilbiss JGA JGV JGK JGHV GFG LMG LMK MSA MSV PGA	KK-4987-2	20-2055	Repair Kit
DeVilbiss MBC	KK-4058-1	20-1146	Repair Kit
DeVilbiss JGHV (HVLP)	KK-4911	20-1596	Repair Kit
Kremlin MX / MR	129.659.901	20-2504	Repair Kit (Package of 3 seals each)
Sharpe 71 / 75PI	16000	20-1794	Repair Kit
Sharpe 775 PI	25196	20-1795	Repair Kit
Titan HVLP	770-389	20-2150	O-Ring Repair Kit

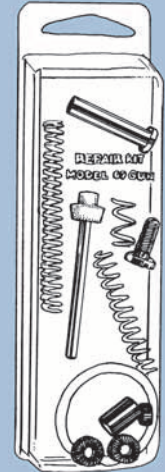

AIRLESS SPRAY GUN REPAIR PARTS

SPRAY GUN	REPLACES OEM PART NO.	BEDFORD PART NO.	DESCRIPTION
AIRLESSCO 007	120-011	58-2001	Valve Spring Unit Assembly
	120-035	58-2022	Valve Seat (Diffuser) Assembly
	120-037	58-2024	Ball & Holder Assembly
	KIT-2-007	20-2031	Minor Repair Kit - includes: Ball & Holder Assy, Valve Seat Assy, (2) Teflon Seals, (3) Tip Washers
	KIT-3-007	20-2032	Complete Repair Kit - includes: Ball & Holder Assy, Valve Seat Assy, Valve Spring Unit (complete), (3) Tip Washers
ASM 300 & 400	4402-F	58-2232	Diffuser with TC Seat (11/16 "F" Thd)
	4402-G	58-2385	Diffuser with TC Seat (7/8 "G" Thread)
	4404	47-2227	Ball Mount & Valve Plunger Assembly
	4405	47-2229	Ball Mount with TC Ball
	4426-F	20-2233	Minor Kit - Diffuser ("F") & Ball Mount
	4426-G	20-2392	Minor Kit - Diffuser ("G") & Ball Mount
	4427-F	20-2234	Gun Repair Kit - Includes: Diffuser ("F"), Ball Mount & Valve Plunger Assy
	4427-G	20-2393	Gun Repair Kit - includes: Diffuser ("G"), Ball Mount & Valve Plunger Assy
	4428	47-2235	Valve Plunger Assembly
	4433-2	55-2721	Gun Filters - 50 Mesh (2-pack)
4434-2	55-2722	Gun Filters - 100 Mesh (2-pack)	
GRACO SILVER GUN: 208-327 208-663 208-664 220-954 GRACO FLEX GUN: 218-132 220-956	218-143	20-1401	Gun Repair Kit - Includes the following: (1) Fluid Needle & Ball Holder Assy (1) Diffuser Housing & Seat Assy (1) Tip Washer (1) Diffuser Gasket

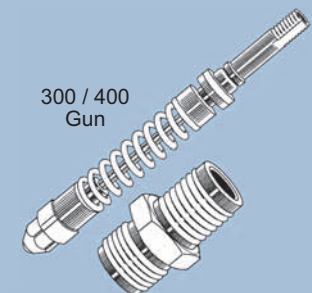
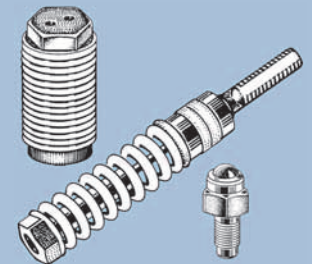

To order, contact your local
Paint Spray Equipment Dealer and ask for
Genuine Bedford Replacement Parts.

BEDFORD® Replacement Parts SPRAY GUN REPAIR PARTS

AIRLESS SPRAY GUN REPAIR PARTS (Continued)



SPRAY GUN	REPLACES OEM PART NO.	BEDFORD PART NO.	DESCRIPTION
GRACO CONTRACTOR: 217-593 220-955 235-990 243-282 820-165 824-950 CONTRACTOR FTx: 238-350 239-045 239-516 243-285 243-374 243-375 824-004 CONTRACTOR ST: 238-352 SG3: 243-238 243-382	218-021	47-2062	Swivel Assembly for Gun Handle
	218-070	20-1502	Gun Repair Kit - Includes the following: (1) Fluid Needle & Ball Holder Assembly (1) Diffuser Assembly (1) Tip Washer, (1) Locknut, (1) Diffuser Gasket
	218-131	14-1484	Fluid Filter Assembly (50 Mesh)
	218-133	14-1485	Fluid Filter Assembly (100 Mesh)
GRACO SILVER +PLUS+ GUN: 235-460 thru 235-464 236-531 237-695 238-591 238-941 238-966 243-283 246-240 FLEX +PLUS+ GUN: 235-457 235-458 235-459 237-691 243-284 246-468	235-474	20-1930	Gun Repair Kit - Includes the following: (1) Fluid Needle Assembly (1) Diffuser Seat Assembly (1) Tip Washer (1) Diffuser Gasket
	GRACO CONTRACTOR II: 246-220 246-221 246-222 246-224 246-225 246-434 246-538 824-987 CONTRACTOR FTx-II: 246-230 thru 246-235 246-435 246-539 246-540	287-031	20-2701
287-032		14-2664	Gun Filter, 60 Mesh, Medium, Black
287-033		14-2665	Gun Filter, 100 Mesh, Fine, Blue
TITAN LX-80 GUN	500-200-03	14-2171	Gun Filter, 30 Mesh, Coarse, Green (2-pack)
	500-200-06	14-2172	Gun Filter, 60 Mesh, Medium, White (2-pack)
	500-200-10	14-2173	Gun Filter, 100 Mesh, Fine, Yellow (2-pack)
	500-200-15	14-2174	Gun Filter, 150 Mesh, Extra-Fine, Red (2-pk)
	580-034	20-2095	Gun Repair Kit - Includes the following: Needle Assy, Diffuser Seat Assembly, Diffuser Gasket, Locknut
TITAN SGX-20 GUN	520-025	20-2088	Gun Repair Kit - Includes the following: Needle Assy, Diffuser Seat Assembly, Diffuser Gasket
WAGNER "G-10" SPRAY GUNS: G-9 / G-9N G-10 / G-10N Parts are also compatible with Amspray EZ-3000 & Larius AT-250 spray guns.	34377	14-832	Filter, Medium (White, 50 Mesh)
	34383	14-834	Filter, Extra-Fine (Red, 180 Mesh)
	43225	58-1495	11/16" Diffuser Housing & Seat Assembly
	89323	14-831	Filter, Coarse (Green, 30 Mesh)
	89324	14-833	Filter, Fine (Yellow, 100 Mesh)
	149342	58-2016	7/8" Diffuser - G10 with Graco "G" Thread
	149700	58-2305	Needle Assembly
	270957	20-1751	Gun Repair Kit - Includes the following: Valve Spring Unit & Ball Holder Assembly, 11/16" Diffuser Assy, X-Fine Filter, Med Filter, Spring, (2) Swivel Washers, (2) Tip Washers, (2) Handle Washers, Locknut
	279625	20-2300	Gun Repair Kit - Includes the following: Valve Spring Unit & Ball Holder Assembly, 7/8" Diffuser Housing & Seat Assembly, Spring, Locknut, Swivel Washer, Tip Washer, Upper Handle Washer
	279919	20-2160	Gun Repair Kit - Includes the following: Valve Spring Unit & Ball Holder Assembly, 7/8" Diffuser Housing & Seat Assembly, Spring, Locknut, Swivel Washer, Tip Washer, Upper Handle Washer
347706	47-2450	Gun Handle Swivel Assembly & Washer	
WAGNER G-10XL and G-12XL	296261	58-2735	Diffuser Seat Assembly
	296294	20-2737	Gun Repair Kit - Includes the following: Needle Assy, Diffuser Seat Assembly, Locknut

AIR PRESSURE REGULATORS

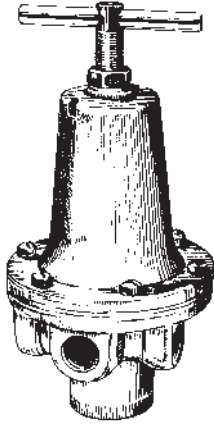

HEAVY DUTY SERIES

Ideal for high capacity continuous service. Relieving type regulators are available in sizes from 1/4" to 1", all sizes have two 1/4" gauge ports.

SPECIFICATIONS

Maximum Initial Pressure 300 PSI
 Output Pressure Range 0-125 PSI
 Operating Temperature Range 40°-120°F

SIZE	MAX SCFM	BEDFORD PART NO.
1/4"	60	26-712
3/8"	90	26-713
1/2"	200	26-714
3/4"	380	26-716
1"	380	26-718

TYPICAL PERFORMANCE FLOW CURVES

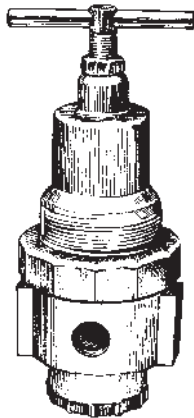
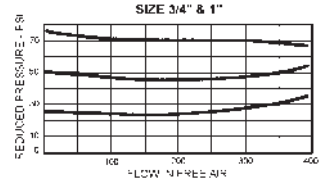
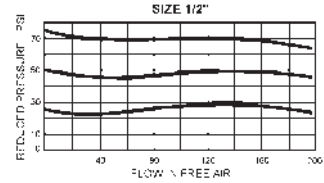
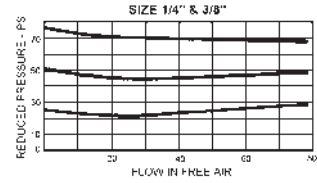

GENERAL PURPOSE SERIES

STANDARD MODEL

With same operating pressure and temperature range as the heavy duty series, this regulator is an economical unit where flow requirements do not exceed 80 SCFM.

1/4" inlet and outlet with two regulated 1/4" gauge ports.

REPLACES DEVILBISS PART NO.	BEDFORD PART NO.
HAR-505	26-1125

SERIES INSTALLATION MODELS

P/N 26-1119 has 3/8" inlet, two 1/4" unregulated ports, and 1/2" regulated outlet.

P/N 26-2328 has 1/4" inlet, 1/4" unregulated port, and two 1/4" regulated outlets.

Specifications same as standard model.

REPLACES DEVILBISS PART NO.	BEDFORD PART NO.
HAR-502	26-2328
HAR-555	26-1119

GAUGES

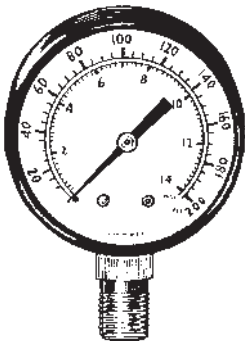

CONNECTION (MALE)	MOUNT	PRESSURE RANGE (PSI)	DIAL DIAMETER	BEDFORD PART NO.
1/8" NPT	BOTTOM	0-60	1-1/2"	28-1358
1/8" NPT	REAR	0-160	1-1/2"	28-706
1/4" NPT	BOTTOM	0-60	2"	28-721
1/4" NPT	BOTTOM	0-100	2"	28-759
1/4" NPT	BOTTOM	0-160	2"	28-766
1/4" NPT	REAR	0-160	2"	28-705
1/4" NPT	BOTTOM	0-160	2-1/2"	28-875
1/4" NPT	BOTTOM	0-200	2"	28-719
1/4" NPT	REAR	0-300	2"	28-704

All gauges have glass face & black finished metal case.

To order, contact your local
Paint Spray Equipment Dealer and ask for
Genuine Bedford Replacement Parts.

BEDFORD® Replacement Parts AIR CONTROL COMPONENTS

FILTERS

Two stage filtration effectively removes airline scale, dirt and moisture. Available in three models listed below with 40 Micron filter element, sizes from 1/4" to 1".

UNIT WITH TRANSPARENT BOWL & GUARD			
SIZE	PART NO.	MAX SCFM	BOWL SIZE
1/4"	25-722	55	5 oz.
3/8"	25-723	75	5 oz.
1/2"	25-724	100	8 oz.

UNIT WITH METAL BOWL & SIGHT GLASS			
SIZE	PART NO.	MAX SCFM	BOWL SIZE
3/4"	25-726	250	16 oz.
1"	25-728	350	16 oz.

UNIT WITH OVERSIZED METAL BOWL			
SIZE	PART NO.	MAX SCFM	BOWL SIZE
1/2"	25-744	100	16 oz.
3/4"	25-746	250	32 oz.
1"	25-748	350	32 oz.

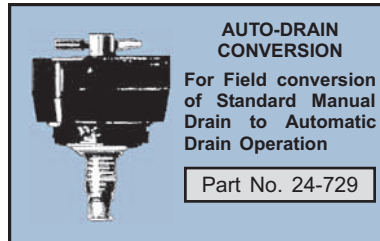

AUTO-DRAIN CONVERSION

For Field conversion
of Standard Manual
Drain to Automatic
Drain Operation

Part No. 24-729

SPECIFICATIONS

Maximum Supply Pressure	(PSI)
Transparent Bowl	150
Metal Bowl w/ Sight Glass	250
Oversized Metal Bowl	300
Operating Temperature	(°F)
Transparent Bowl	40°-120°
Metal Bowl w/ Sight Glass	40°-150°
Oversized Metal Bowl	40°-180°

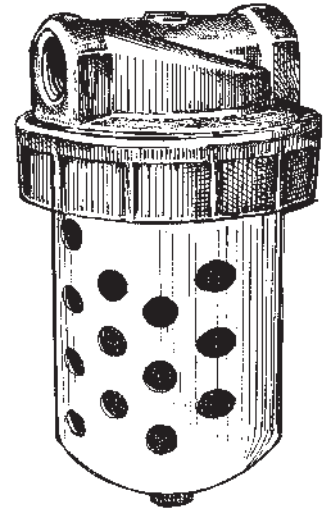

LUBRICATORS

Dial set adjustment and full view drip tube for simple operation. Unit may be filled while pressurized without shutting down equipment. Available in three models listed below, sizes from 1/4" to 1".

UNIT WITH TRANSPARENT BOWL & GUARD			
SIZE	PART NO.	MAX SCFM	BOWL SIZE
1/4"	27-732	40	5 oz.
3/8"	27-733	70	5 oz.
1/2"	27-734	112	8 oz.

UNIT WITH METAL BOWL & SIGHT GLASS			
SIZE	PART NO.	MAX SCFM	BOWL SIZE
3/4"	27-736	290	16 oz.
1"	27-738	320	16 oz.

UNIT WITH OVERSIZED METAL BOWL			
SIZE	PART NO.	MAX SCFM	BOWL SIZE
1/2"	27-754	112	16 oz.
3/4"	27-756	290	32 oz.
1"	27-758	320	32 oz.

SPECIFICATIONS

Maximum Supply Pressure	(PSI)
Transparent Bowl	150
Metal Bowl w/ Sight Glass	250
Oversized Metal Bowl	300
Operating Temperature	(°F)
Transparent Bowl	40°-120°
Metal Bowl w/ Sight Glass	40°-150°
Oversized Metal Bowl	40°-180°

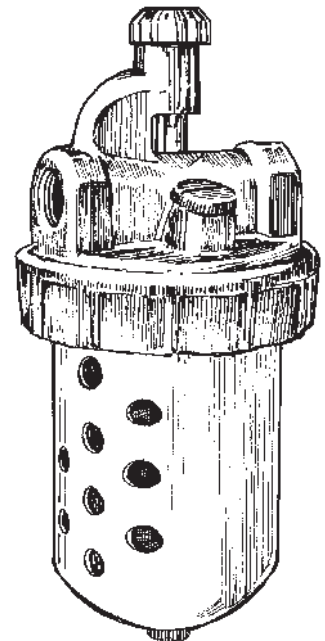

MINIATURE SERIES

These components are specifically designed for applications where a small economical unit is required. Especially useful on air tools, cylinders, valves, paint sprayers, and pressurized tanks.

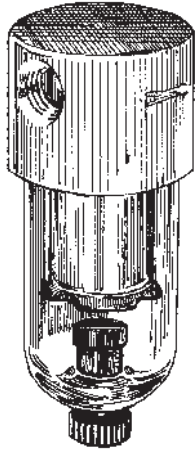

MINI FILTER

Two stage filtration removes airline scale, dirt and moisture. Has 20 Micron filter element, aluminum body, and shatterproof clear polycarbonate bowl. Connections are 1/4" and the bowl capacity is 1 oz.

SPECIFICATIONS

Flow 22.0 SCFM
Maximum Supply Pressure 150 PSI
Operating Temperature 40°-120° F
Height: 4" Dia: 1-9/16" Weight: 1/4 lb

PART NO.
25-720

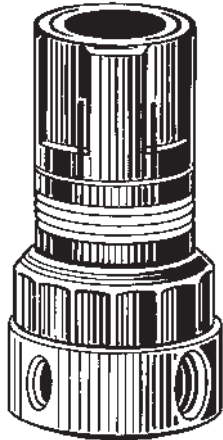
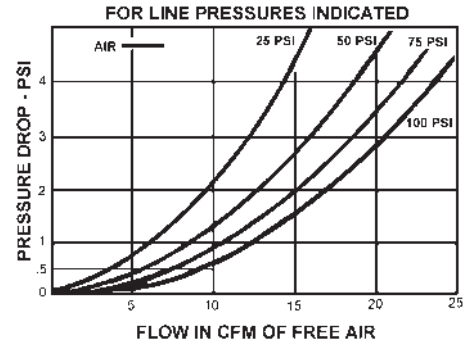

MINI REGULATOR

Relieving type regulator has aluminum body and acetyl spring cage and adjusting knob. 1/4" inlet and outlet ports with two 1/8" gauge ports for use with P/N 28-706 & 28-1358 gauges.

SPECIFICATIONS

Flow 16.0 SCFM
Maximum Supply Pressure 300 PSI
Output Pressure Range 0-125 PSI
Operating Temperature 40°-120° F
Height: 3" Dia: 1-9/16" Weight: 1/4 lb

PART NO.
26-710

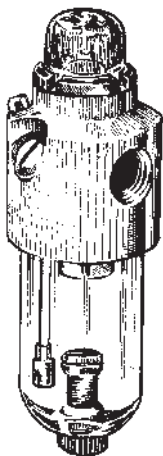
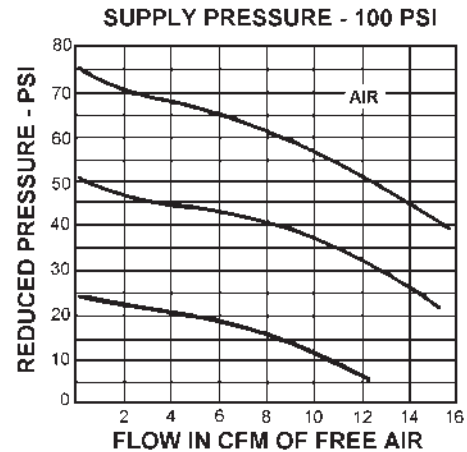

MINI LUBRICATOR

Unit has rugged aluminum body and shatterproof clear polycarbonate bowl and two large fill ports for quick filling. Connections are 1/4". 1 oz. bowl capacity.

SPECIFICATIONS

Flow 12.0 SCFM
Maximum Supply Pressure 150 PSI
Operating Temperature 40°-120° F
Height: 4-7/16" Dia: 1-9/16" Weight: 1/4 lb

PART NO.
27-730

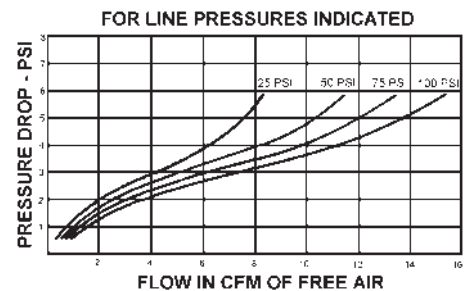

To order, contact your local
Paint Spray Equipment Dealer and ask for
Genuine Bedford Replacement Parts.

BEDFORD® Replacement Parts

AIR CONTROL COMPONENTS

AIR RELIEF SAFETY VALVE

Air relief safety valves have all brass body construction with stainless steel ball, forming metal to metal valve seal assuring reliable performance and long life. 1/4" NPT male connection. Maximum temperature 300° F. ASME Approved.

DESCRIPTION	RELIEF PRESSURE (PSI)	BEDFORD PART NO.
Air Relief Safety Valve	80	29-1676
	110	29-941



AIR CONTROL COMPONENT REPLACEMENT PARTS

REGULATOR REPAIR PARTS

DESCRIPTION	FOR UNIT NO.	BEDFORD PART NO.
Repair Kit	26-1119, 26-1125, 26-2328	24-1126
Repair Kit	26-712 & 26-713	24-725
Repair Kit	26-714	24-727
Repair Kit	26-716 & 26-718	24-731
Cage & Knob	26-710	24-1023
T-Handle & Cage	26-1119, 26-1125, 26-2328	24-1024
T-Handle	26-712 & 26-713	24-1020
T-Handle	26-714	24-1021
T-Handle	26-716 & 26-718	24-1022

FILTER REPAIR PARTS

DESCRIPTION	FOR UNIT NO.	BEDFORD PART NO.
Filter Element	25-720	24-1028
Filter Element	All 1/4" & 3/8"	24-814
Filter Element	All 1/2"	24-815
Filter Element	All 3/4" & 1"	24-816
Baffle Assembly	All 1/4" & 3/8"	24-1025
Baffle Assembly	All 1/2"	24-1026
Baffle Assembly	All 3/4" & 1"	24-1027

LUBRICATOR REPAIR PARTS

DESCRIPTION	FOR UNIT NO.	BEDFORD PART NO.
Cap, Tube & O-Ring	All Standard Units	24-1029
Adjusting Cap	All Standard Units	24-1035
Filler Plug	All Standard Units	24-1033
Repair Kit	All Standard Units	24-1031

REPLACEMENT TRANSPARENT BOWL

DESCRIPTION	FOR UNIT NO.	BEDFORD PART NO.
Bowl	25-720 & 27-730	24-1030
Bowl with Guard	All 1/4" & 3/8"	24-739
Bowl with Guard	All 1/2"	24-740
Drain Cock	Transparent Bowls	24-1038

REPLACEMENT METAL BOWL WITH SIGHT GLASS

DESCRIPTION	FOR UNIT NO.	BEDFORD PART NO.
Bowl	All 3/4" & 1"	24-741
Sight Glass Only	24-741 Bowl	24-1037

MOUNTING BRACKETS

DESCRIPTION	FOR UNIT NO.	BEDFORD PART NO.
Bracket & Nut	Mini-Regulator	24-1968
Nut Only	Mini-Regulator	24-1972
Bracket & Nut	26-1125, 26-1119, 26-2328	24-1969
Nut Only	26-1125, 26-1119, 26-2328	24-1973
Bracket	26-712 & 26-713	24-1970
Bracket	26-714	24-1971

BEDFORD® Replacement Parts Technical Data

To order, contact your local
Paint Spray Equipment Dealer and ask for
Genuine Bedford Replacement Parts.

Chemical Resistance of Materials – Fluid Compatibility Data

Type of Fluid	NY	TE	VI	LE
Acetate Solvents	1	1	0	0
Acetic Acid	3	1	3	3
Acetone	1	1	3	2
Acetylene	1	1	1	1
Air	1	0	0	0
Air (Hot)	1	0	0	0
Alcohols	2	1	1	1
Ammonia (Anhydrous) Liquid	3	1	3	3
Ammonia (Gas)	2	0	0	0
Ammonium Hydroxide	2	1	1	2
Ammonium Chloride	3	1	1	0
Aniline	3	1	2	0
Aliphatic Hydrocarbons	1	0	0	0
Aromatic Hydrocarbons	1	0	0	0
Auto Transmission Fluid	1	0	0	0
Barium Chloride	3	1	1	1
Barium Sulphide	2	1	1	1
Benzene (Benzol)	1	1	3	2
Boric Acid	2	1	1	1
Bromine	3	1	1	3
Butane	1	1	1	2
Butyl Alcohol (Butanol)	2	1	0	0
Butyl Acetate	1	1	3	2
Calcium Chloride	2	1	1	1
Carbolic Acid	3	1	1	3
Carbonic Acid	2	1	1	1
Chlorine (Wet)	3	1	0	0
Chloro Methane (Methylene Chloride)	2	1	1	0

Type of Fluid	NY	TE	VI	LE
Citric Acid	2	1	1	0
Cresol	3	1	1	3
Diesel Fuel	1	1	1	1
Ethanol	2	1	1	2
Ethers	1	1	3	2
Ethyl Acetate	1	1	3	2
Ethylene Glycol ●	2	1	1	0
Formaldehyde	2	1	1	3
Gasoline	1	1	1	1
Hydraulic Fluid (Petroleum Based)	1	1	1	1
Hydraulic Fluid (Phosphate Ester) ●	2	1	1	2
Hydraulic Fluids (Water/Glycol) ●	2	1	0	0
Hydrochloric Acid	3	1	1	2
Hydrogen Peroxide	3	1	1	1
Isopropyl Alcohol	2	1	1	2
Isocyanates ▲	3	0	0	0
Kerosene	1	1	1	1
Ketones	1	1	3	2
Lacquers & Solvents	1	1	3	2
Linseed Oil	1	1	1	1
Lubricating Oils (Petroleum Base)	1	1	1	1
Lubricating Oils (Diester Base)	1	0	0	0
Mercury	1	1	1	1
Mercuric Chloride	2	1	1	0
Methanol	2	1	1	2
Methyl Ethyl Ketone (MEK)	1	1	3	2
Methylene Chloride	2	1	1	0
Mineral Oil	1	1	1	1

Type of Fluid	NY	TE	VI	LE
Naphtha	1	1	1	1
Natural Gas	1	1	0	0
Nitric Acid (70%)	3	3	0	0
Oleic Acid	2	1	1	1
Oxalic Acid	2	1	1	2
Oxygen	2	3	0	0
Paint (Oil / Alkyn Based)	1	1	2	1
Paint (Water Based) ●	1	1	1	1
Phenol	3	1	2	3
Potassium Salt Solutions	2	1	0	0
Refrigerant 12	1	0	0	0
Refrigerant 22	1	0	0	0
Refrigerant 502	1	0	0	0
Sodium Chloride Solution	2	1	1	1
Sodium Hydroxide (<20%)	2	1	1	3
Sodium Hypochlorite Solution	3	1	1	0
Steam	3	0	0	0
Sulphuric Acid	3	1	1	3
Trichlorethylene	2	1	0	0
Toluene (Toluol)	1	1	2	2
Turpentine	1	1	1	2
Varnishes & Solvents	1	1	0	2
Water, Fresh (Cold)	1	1	1	1
Water, Salt (Cold)	2	1	1	1
Water, Fresh (Hot over 66°C)	3	1	1	3
Water, Salt (Hot over 66°C)	3	1	1	3
Xylene	1	1	3	2
Zinc Chloride Solutions	3	1	1	1

MATERIAL CODE: NY - Nylon TE - Teflon VI - Viton LE - Leather

RESISTANCE CODE: 1 - Little or no effect 2 - Minor or moderate effect 3 - Severe Effect 0 - Not tested

● Recommended operating temperature not to exceed 160°F

▲ Precautions must be taken to keep moisture from permeating hose

*The information given is based on research and experience and to the best of our knowledge is reliable.
However, we must emphasize that the chart should be used as a guide only.*

Pipe Thread Sizing Guide

To size a **Male NPT or NPS thread**, determine which of the guide circles below best represents the thread's **outside diameter**.



To size a **Female NPT or NPS thread**, determine which of the guide circles below best represents the thread's **inside diameter**.

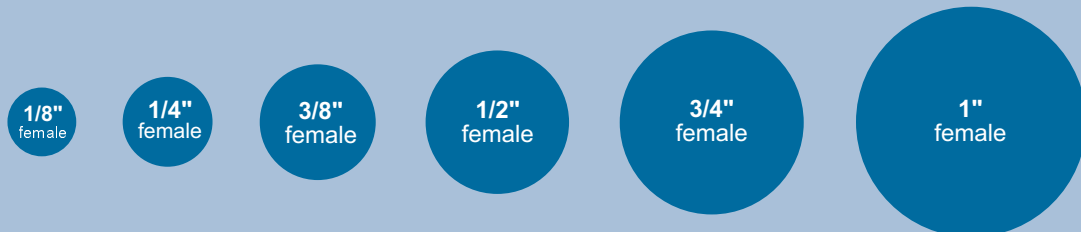

To order, contact your local
Paint Spray Equipment Dealer and ask for
Genuine Bedford Replacement Parts.

BEDFORD® Replacement Parts Index

ITEM	PAGE
ADAPTERS	
Low Pressure	61, 62
Swivel Unions, High Pressure	62
AIR CONTROL COMPONENTS	
Filters, Air Line	69
Lubricators, Air Line	69
Miniature Series	70
Regulators, Air Line	68
AIRLESSCO	
Glidden Pumps, Quick Reference	47
Replacement Parts for	3-4
Spray Guns, Quick Reference	66
AMSPRAY	
Glidden Pumps, Quick Reference	47
Pump Components, Quick Reference	48
Replacement Parts for	47-53
ASM	4
BINKS	
Pump Components, Quick Reference	5
Replacement Parts for	5-11
Spray Guns, Quick Reference	5, 66
CLOTHING, Disposable, Protective	54
CONNECTORS, Hose	59
COUPLINGS	
Hose	59
Quick Disconnect	59, 61
CUP ASSEMBLY, Quart Siphon	57
DEVILBISS	
Replacement Parts for	12-13
Spray Guns, Quick Reference	66
FILTERS	
Airless Gun	63
Air Line	69-70
Air Line, Miniature	70
Inlet Strainers	64
Inline, Fluid	63
Manifold	65
Tip	63
FITTINGS, Hose	58-59, 61-62
FULLER O'BRIEN, Pump Interchange	48
GASKETS, Cup and Tank Lid	55
GAUGES	68
GLIDDEN	
Airlessco Private Label, Pump Kits	47
Amspray Private Label, Pump Components	47-48
Wagner Private Label, Pump Kits	47
GRACO	
Replacement Parts for	14-34
Spray Guns, Quick Reference	66-67
GUN, Spray, Repair Parts	66-67
H.E.R.O.	
Pump Components, Quick Reference	35
Replacement Parts for	36-37
HOSE	
Air & Fluid, Low Pressure	58-59
Airless Spray	60
Pressure Washer	59
KREMLIN	46
LARIUS	46
LUBRICATORS	
Air Line	69
Air Line, Miniature	70
M.A.B., Pump Interchange	48
NIPPLES	62
PLUGS	62
PRESSURE WASHER HOSE	59
QUICK DISCONNECTS	59, 61

ITEM	PAGE
QUICK REFERENCES	
Airlessco Pump Kits	47
Airlessco Spray Guns	66
Amspray Pump Components	48
ASM Spray Guns	66
Binks Pump Components	5
Binks Spray Guns	5, 66
Devilbiss Spray Guns	66
Glidden Pumps, Private Labeled by Amspray	47-48
Glidden Pumps, Private Labeled by Wagner	47
Glidden Pumps, Private Labeled by Airlessco	47
Graco Spray Guns	66-67
H.E.R.O. Pump Components	35
Sharpe Spray Guns	66
Titan Spray Guns	67
Wagner Spray Guns	67
REGULATORS	
Air Pressure	68
Air Pressure, Miniature	70
REPLACEMENT PARTS FOR...	
Airlessco	3-4
Amspray	47-53
ASM	4
Binks	5-11
Devilbiss	12-13
Glidden, Private Label Pumps	47
Graco	14-34
H.E.R.O.	35-37
Kremlin	46
Larius	46
Sharpe	37
Speeflo	38-45
Titan	38-45
Wagner	47-53
SHARPE	
Replacement Parts for	37
Spray Guns, Quick Reference	66
SINCLAIR, Pump Interchange	48
SPEEFLO	
Replacement Parts for	38-45
SPRAY GUN REPAIR KIT REFERENCES	
Airlessco	66
Binks	5, 66
Devilbiss	66
Graco	66-67
Sharpe	66
Titan	67
Wagner	67
STRAINER BAGS, Paint	54
STRAINERS, Inlet	64
TITAN	
Replacement Parts for	38-45
Spray Gun Kits, Quick Reference	66-67
VALVES	
Air Metering, "Cheater"	57
Air Relief, Safety	71
Ball Valves	56-57
Dump Valves, High Pressure	56
WAGNER	
Amspray Pump Components, Quick Reference	47-48
Spray Guns, Quick Reference	66-67
Piston Pump Kits, Quick Reference	46-48
Replacement Parts for	47-53

Your local Bedford dealer is:

ORDER
FORM



PAGE 2

PARTS
FOR

AIRLESSCO

EQUIPMENT

PAGES 3-4

PARTS
FOR

AMSPRAY
GLIDDEN
FULLER O'BRIEN
M.A.B.
SINCLAIR

EQUIPMENT

PAGES 47-53

PARTS
FOR

ASM

EQUIPMENT

PAGE 4

PARTS
FOR

BINKS

EQUIPMENT

PAGES 5-11

PARTS
FOR

DEVILBISS

EQUIPMENT

PAGES 12-13

PARTS
FOR

GLIDDEN

EQUIPMENT

PAGE 47

PARTS
FOR

GRACO

EQUIPMENT

PAGES 14-34

PARTS
FOR

H.E.R.O.

EQUIPMENT

PAGES 35-37

PARTS
FOR

KREMLIN

EQUIPMENT

PAGE 46

PARTS
FOR

LARIUS

EQUIPMENT

PAGE 46

PARTS
FOR

SHARPE

EQUIPMENT

PAGE 37

PARTS
FOR

**TITAN /
SPEEFLO**

EQUIPMENT

PAGES 38-45

PARTS
FOR

WAGNER

EQUIPMENT

PAGES 47-53

PAINT STRAINERS



PAGE 54

DISPOSABLE
CLOTHING



PAGE 54

TANK & CUP
LID GASKETS

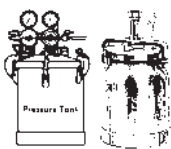

PAGE 55

VALVES



PAGES 56-57

HOSE &
ASSEMBLIES

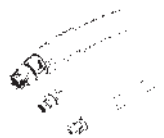

PAGES 58-60

FITTINGS &
ADAPTERS



PAGES 61-62

FILTERS &
STRAINERS



PAGES 63-65

SPRAY GUN
REPAIR PARTS



PAGES 66-67

**To order, contact your local
Paint Spray Equipment Dealer
and ask for Genuine
Bedford Replacement Parts.**

GAUGES



PAGE 68

AIR CONTROL
COMPONENTS



PAGES 68-71

RELIEF VALVES



PAGE 71